

CONNEX HD VIDEO YOU CAN FLY WITH

CONNEXTM / CONNEX MiniTM **User Guide**



Simply Plug-and-Fly!

CONNEX

Version 3.0

www.amimon.com

Table of Contents

Chapter 1: About This Guide	1
Important Notice	1
Limitation of Liability and Warranty	2
Chapter 2: Introduction to CONNEX	4
About CONNEX and CONNEX Mini.....	4
CONNEX Air Unit (Transmitter).....	7
CONNEX Ground Unit (Receiver).....	10
CONNEX Mini Air Unit (Transmitter).....	14
CONNEX Mini Ground Unit (Receiver).....	18
Getting Started - Air and Ground Units.....	21
Chapter 3: Safety Instructions and Maintenance	22
Safety Symbols and Instructions.....	22
Potential Hazards.....	23
Chapter 4: Specifications and Supported Features	24
Technical Specifications.....	25
Supported Remote Controls, Gimbals and Telemetry Flight Controllers.....	26
Supported Resolutions.....	27
Chapter 5: Setting Up CONNEX	28
Recommendations and Best Practices	28
Placement Guidelines – Air Unit Cable Antennas	28
Placement Guidelines – Ground Unit.....	31
Setting Up the CONNEX Ground Unit.....	31
Setting Up the CONNEX Air Unit.....	34
Mounting the Air Unit Antenna Accessories	37
Connecting the Telemetry/MAVLink Port.....	39
Controlling the Drone Camera Gimbal.....	39
Chapter 6: Setting Up CONNEX Mini	40
Setting Up the CONNEX Mini Ground Unit.....	40

Setting Up the CONNEX Mini Air Unit.....	42
Connecting the CTRL Port for MAVLink Telemetry.....	46
Connecting the CTRL Port for CAN bus Telemetry.....	47
Controlling the Drone Camera Gimbal.....	48
Chapter 7: CONNEX Operational Instructions	49
Ground Unit – On Screen Display (OSD).....	49
Alert and System Messages.....	53
Multicasting to Multiple Ground Units.....	54
Chapter 8: CONNEX Management Application for Windows / MAC	55
Management Application Overview.....	55
Installing the CONNEX Management Application.....	56
Message Alert when running the Management Tool Installation Process in Win8/10.....	57
Connecting the Air Unit or Ground Unit to a Computer.....	58
Upgrading the Air Unit or Ground Unit Firmware.....	59
Configuring the Link Between the Ground and Air Units.....	61
Checking the Ground Units Registered to an Air Unit.....	63
Unregistering Ground Units.....	64
Configuring Fail Safe Parameters.....	66
Chapter 9: CONNEX Management Application for Android Devices	68
Management Application Overview.....	68
Installing the CONNEX Management Application.....	69
Connecting the Air or Ground Unit to Your Mobile Device.....	70
Working with the CONNEX Mobile Application.....	71
Configuring the Link Between the Ground and Air Units.....	74
Checking the Ground Units Registered to an Air Unit.....	76
Unregistering Ground Units.....	77
Configuring Fail Safe Parameters.....	79

1

About This Guide

This user guide describes how to set up and use the CONNEX and CONNEX mini wireless video link in order to transmit video from a drone. The user guide consists of the following chapters:

- Chapter 1, About This Guide - this chapter
- Chapter 2, [Introduction to CONNEX](#)
- Chapter 3, [Safety Instructions and Maintenance](#)
- Chapter 4, [Specifications and Supported Features](#)
- Chapter 5, [Setting Up CONNEX](#)
- Chapter 6, [Setting Up CONNEX mini](#)
- Chapter 7, [Recommendations and Best Practices](#)
- Chapter 8, [CONNEX Operational Instructions](#)
- Chapter 9, [CONNEX Management Application for Windows and MAC](#)
- Chapter 10, [CONNEX Management Application for Android Devices](#)

For a quick summary of the essential steps for setting up quickly, you may refer to the [CONNEX Quick Setup Guide](#) or the [CONNEX mini Quick Setup Guide](#).

Support and Contact Information

Support: <https://connexuav.zendesk.com/hc/en-us>.

When contacting a support representative, make sure to have the Air Unit's and Ground Unit's serial numbers available. These numbers appear on the label on the bottom of each device.

Important Notice

Copyright © 2016 AMIMON. All rights reserved.

All intellectual property rights are owned by AMIMON and protected by applicable copyright laws and international treaty provisions. All software/hardware is furnished under a license agreement. All other trademarks are the property of their respective owners.

AMIMON reserves the right to make corrections, modifications, enhancements, improvements, and other changes to its products and services at any time and to discontinue any product or service without notice. Customers should obtain the latest relevant information before placing orders and should verify that such information is current and complete. All products are sold subject to AMIMON's terms and conditions of sale supplied at the time of order acknowledgment.

AMIMON warrants performance of its hardware products to the specifications applicable at the time of sale in accordance with AMIMON's standard warranty. Testing and other quality control techniques are used to the extent AMIMON deems necessary to support this warranty. Except where mandated by government requirements, testing of all parameters of each product is not necessarily performed.

AMIMON assumes no liability for applications assistance or customer product design. Customers are responsible for their products and applications using AMIMON components. To minimize the risks associated with customer products and applications, customers should provide adequate design and operating safeguards.

AMIMON does not warrant or represent that any license, either express or implied, is granted under any AMIMON patent right, copyright, mask work right, or other AMIMON intellectual property right relating to any combination, machine, or process in which AMIMON products or services are used. Information published by AMIMON regarding third-party products or services does not constitute a license from AMIMON to use such products or services or a warranty or endorsement thereof. Use of such information may require a license from a third party under the patents or other intellectual property of the third party, or a license from AMIMON under the patents or other intellectual property of AMIMON.

Reproduction of information in AMIMON data books or data sheets is permissible only if reproduction is without alteration and is accompanied by all associated warranties, conditions, limitations, and notices. Reproduction of this information with alteration is an unfair and deceptive business practice. AMIMON is not responsible or liable for such altered documentation.

Resale of AMIMON products or services with statements different from or beyond the parameters stated by AMIMON for that product or service voids all express and any implied warranties for the associated AMIMON product or service and is an unfair and deceptive business practice. AMIMON is not responsible or liable for any such statements.

All company and brand products and service names are trademarks or registered trademarks of their respective holders.

Before operating or installing CONNEX or CONNEX mini, please ensure you read the respective warranty.

Limitation of Liability and Warranty

This CONNEX™ product is provided “as is” without warranty of any kind. The company disclaims all other warranties, either express or implied, including but not limited to implied warranties of merchantability and fitness for a particular purpose and non-infringement.

Under no circumstances shall the company be liable for any damages whatsoever (including, without limitation, consequential, special, or incidental damages or damages for loss of business profits, business interruptions, loss of business information or other pecuniary loss) arising out of the use of or inability to use the CONNEX product, even if the company has been advised of the possibility of such damages.

For the full terms and conditions, please go to the online [Full Terms and Conditions](#).

NOTICE TO CUSTOMERS

Notice Required for the License Granted under Articles 2.1 and 2.6. As a condition of the licenses granted pursuant to Articles 2.1 and 2.6 hereof, Licensee agrees to provide to any party that receives from Licensee an AVC Royalty Product the following notice: THIS PRODUCT IS LICENSED UNDER THE AVC PATENT PORTFOLIO LICENSE FOR THE PERSONAL USE OF A CONSUMER OR OTHER USES IN WHICH IT DOES NOT RECEIVE REMUNERATION TO (i) ENCODE VIDEO IN COMPLIANCE WITH THE AVC STANDARD (“AVC VIDEO”) AND/OR (ii) DECODE AVC VIDEO THAT WAS ENCODED BY A CONSUMER ENGAGED IN A PERSONAL ACTIVITY AND/OR WAS OBTAINED FROM A VIDEO PROVIDER LICENSED TO PROVIDE AVC VIDEO. NO LICENSE IS GRANTED OR SHALL BE IMPLIED FOR ANY OTHER USE. ADDITIONAL INFORMATION MAY BE OBTAINED FROM MPEG LA, L.L.C. SEE [HTTP://WWW.MPEGLA.COM](http://www.mpegla.com)

Notice Required for the License Granted under Article 2.6 and for Sales to Codec Licensee customer(s). As a condition of the license granted under Article 2.6 and the license granted to a Codec Licensee to make sales to Codec Licensee Customer(s), Licensee agrees to provide any party that receives an AVC Product from Licensee exercising such license rights the following notice: THIS PRODUCT IS LICENSED UNDER THE AVC PATENT PORTFOLIO LICENSE. SUCH LICENSE EXTENDS TO THIS PRODUCT ONLY AND ONLY TO THE EXTENT OF OTHER NOTICES WHICH MAY BE INCLUDED HEREIN. THE LICENSE DOES NOT EXTEND TO ANY OTHER PRODUCT REGARDLESS OF WHETHER SUCH PRODUCT IS INCLUDED WITH THIS LICENSED PRODUCT IN A SINGLE ARTICLE. ADDITIONAL INFORMATION MAY BE OBTAINED FROM MPEG LA, L.L.C. SEE [HTTP://WWW.MPEGLA.COM](http://www.mpegla.com)



This equipment is in compliance with the essential requirements and other relevant provisions of

Directives 1999/5/EC and 2011/65/EU.

The frequency range 5.15-5.35GHz, available under Indoor mode, is for indoor use only.

FCC Caution

Any changes or modifications not expressly approved by AMIMON may void the user's authority to operate this equipment.

Note: This equipment has been tested and found to comply with the limitations for a Class B digital device, pursuant to part 15 of the FCC Rules. These limits are designed to provide reasonable protection against harmful interference in a residential installation. This equipment generates, uses and can radiate radio frequency energy. If this equipment is not installed and used in accordance with the instructions, it may cause harmful interference to radio communications. However, there is no guarantee that interference will not occur in a particular installation.

FCC Radiation Exposure Statement

This equipment complies with FCC RF radiation exposure limits set forth for an uncontrolled environment. This transmitter must not be co-located or operating in conjunction with any other antenna or transmitter. This equipment complies with Part 15 of the FCC Rules. Operation is subject to the following two conditions:

- This device may not cause harmful interference.
- This device must accept any interference received, including interference that may cause undesired operation.

The antenna used for transmission must be installed to provide a separation distance of at least 20cm from all persons and must not be co-located or operating in conjunction with any other antenna or transmitter.

About AMIMON

Established in 2004, AMIMON develops and manufactures HD wireless video systems recognized as the standard solution of realtime wireless video for the pro-Camera, unmanned, medical, A/V installation and other markets. Its highly disruptive digital and RF semiconductor video modem technology addresses the stringent requirements of *realtime HD video connectivity* augmented by multicast and control capabilities.

2

Introduction to CONNEX

This chapter presents:

- [About CONNEX and CONNEX mini](#)
- [CONNEX Air Unit \(Transmitter\)](#)
- [CONNEX Ground Unit \(Receiver\)](#)
- [CONNEX mini Air Unit \(Transmitter\)](#)
- [CONNEX mini Ground Unit \(Receiver\)](#)
- [Getting Started: Air and Ground Units](#)

About CONNEX and CONNEX Mini

AMIMON's CONNEX and CONNEX mini provide a high-end, high-performance wireless HD connection that can operate in challenging unmanned air or ground platforms under harsh conditions with zero latency, such as UAV/UGV. The small and lightweight CONNEX systems transmit commercial, industrial, inspection and monitoring video in real time to their Ground Unit(s), which can be located up to 1,000 meters away.

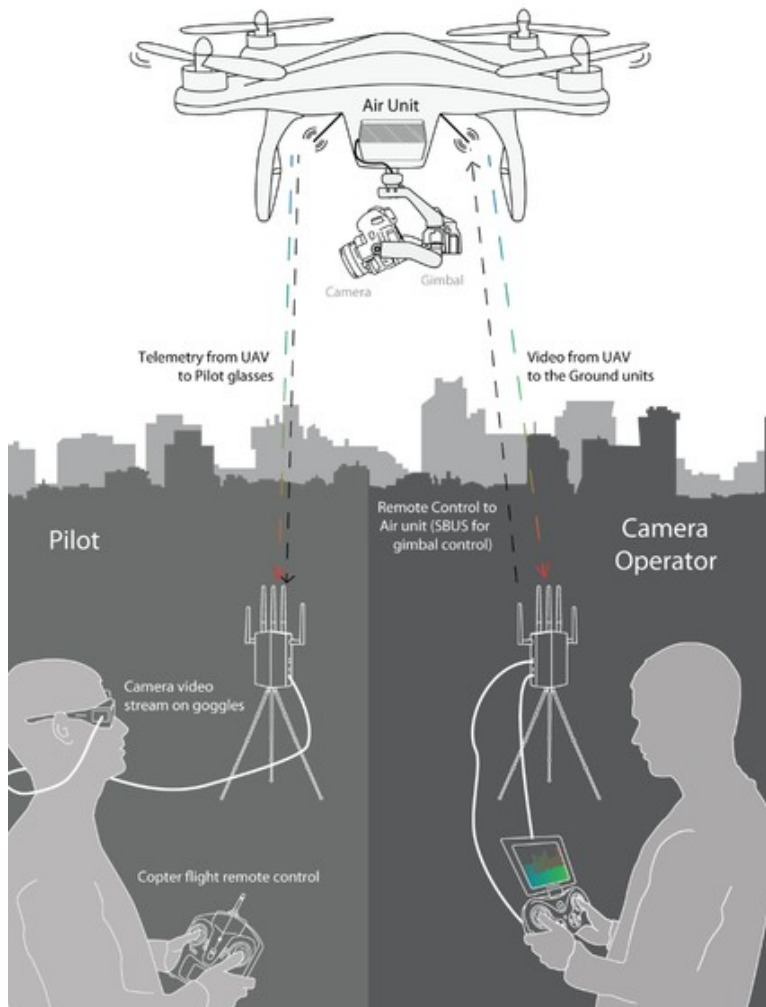

How CONNEX Works

The figure above contains the following main components and people:

- **Air Unit:** The Air Unit is connected to a drone in order to capture video from the drone's camera and to transmit it to up to four Ground Units simultaneously (multicast), thus creating a wireless video link.
- **Ground Unit:** The Ground Unit connects to various types of monitors, video goggles or a portable video monitor via the HDMI port. This enables the pilot and/or camera operator to monitor the video transmitted from the Air Unit.
- **Pilot:** The pilot can view the video on a monitor or wear video goggles connected to the Ground Unit. Flight control (telemetry) information from the drone is overlaid on the video. The pilot uses a remote flight controller to control the drone.
- **Camera Operator:** The camera operator can hold a portable video monitor on which the video can be viewed. The camera operator can use a gimbal remote control to control the drone camera's gimbal through the S.BUS port of the Air Unit.

Key Features

The following features apply to both the CONNEX and the CONNEX mini:

- Zero latency, real-time video
- True full HD 1080P at 60fps
- Extremely resilient 5GHz digital link
- Automatic Frequency Selection (AFS) that fully complies with regulations and automatically selects the best free frequency available
- Encrypted and secure
- Sturdy design for harsh conditions
- Built-in OSD view with embedded telemetry
- Gimbal control over Futaba® S.BUS and PPM
- Plug-and-Fly, ready to operate out of the box
- DFS support enables multiple free channels, thus boosting robustness
- Android and MAC / Windows-based management support application

The following table compares the technical capabilities of the CONNEX and the CONNEX mini:

CONNEX	CONNEX mini
Up to 1,000m / 3,000 ft range (LOS)	Up to 500m / 1,500 ft range (LOS)
Supports both 40 MHz bandwidth (for best quality) and 20 MHz bandwidth (for stability boost)	Supports 40 MHz bandwidth
Manual frequency selection option that enables setting a specific non-DSF frequency in the authorized regional spectrum	No manual frequency selection option

In the Box

The CONNEX systems are comprised of an Air Unit (transmitter) and a Ground Unit (receiver). For details about the components of the Air and Ground Units and the accessories provided with each, refer to the following sections:

- [CONNEX Air Unit \(Transmitter\)](#)
- [CONNEX Ground Unit \(Receiver\)](#)
- [CONNEX mini Air Unit \(Transmitter\)](#)
- [CONNEX mini Ground Unit \(Receiver\)](#)

CONNEX Air Unit (Transmitter)

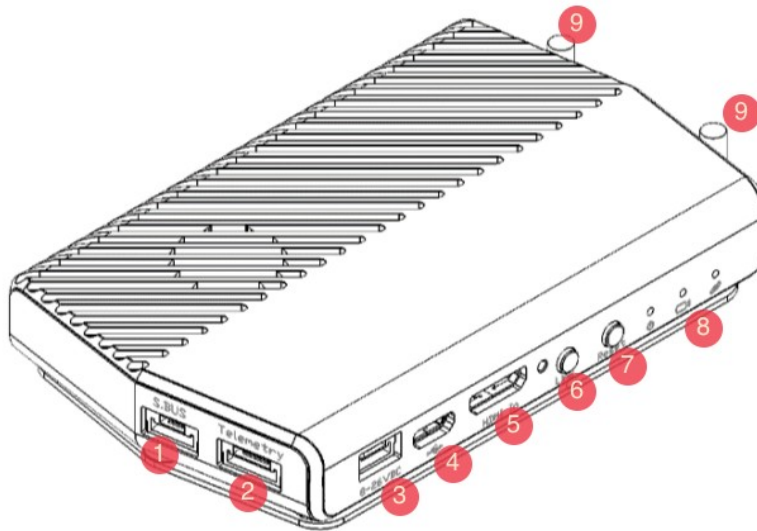

Key	Title	Description
1	S.BUS or CAN bus / S.BUS	<p>I/O port, connecting to the flight controller (CAN bus) and control of the camera gimbal (S.BUS).</p> <p>AMIMON provides two types of cables for this port:</p> <ul style="list-style-type: none"> • S.BUS-only cable: For output of S.BUS control signals to the S.BUS input on the camera gimbal. • CAN bus-S.BUS cable: Allowing both CAN bus telemetry input from the A2/NAZA flight controller (to be overlaid on the video via OSD) and S.BUS control output to the S.BUS input on the camera gimbal. <p>S.BUS properties can be configured using the CONNEX Management Application for Windows / MAC or for Android devices.</p> <p>NOTE : AMIMON recommends using the CONNEX link for Gimbal control ONLY and NOT for full drone control.</p> <p>Important:</p> <ul style="list-style-type: none"> • The CAN bus port and USB port (for firmware upgrade) should not be connected at the same time. • Do not connect the S.BUS/CAN bus cable under voltage.
2	Telemetry or MAVLink	<p>This port is used for MAVLink protocol input from a 3DR flight controller (Pixhawk/ APM/ArduPilot). The flight control data from the MAVLink-supported flight controller is overlaid on an On Screen Display (OSD). Telemetry information includes flight mode, number of connected GPS satellites, speed, height and more. To receive telemetry data on the Ground Unit, the Air Unit should be connected to the drone's telemetry port. For more information, refer to Supported Remote Controls, Gimbals and Telemetry Flight Controllers.</p>

3	Power Connector	Input rating: 8-26 VDC (3–6 cells).
4	Micro USB Port	This port enables configuration and upgrade of the Air Unit software using the CONNEX Management Application for Windows / MAC or for Android devices .
5	mini HDMI IN	For receiving video from the camera.
6	Link Button	The Air Unit is provided pre-paired (preregistered) with the Ground Unit that comes in the box. The Link button can be used to pair up to three additional Ground Units with the same Air Unit. For a description of how to pair additional Ground Units with an Air Unit, refer to Multicasting to Multiple Ground Units .
7	Reset Button	Resets the Air Unit.
8	LEDs	For a description of the Air Unit LEDs, refer to: <ul style="list-style-type: none"> • Air Unit – Power LED • Air Unit – Video LED • Air Unit - Network LED
9	Tx Cable Antenna Ports	Two ports for connecting lightweight 2dbi cable antennas.

Air Unit Accessories

The box number in which each cable is provided is indicated in the table below.

Name	Description	
Tx Cable Antennas	Two flat lightweight 2dbi cable antennas. Box 2.	
Cable Antenna Mounting Accessories	Plastic accessories for mounting the antennas on the drone. Box 2.	
Micro to mini HDMI Cable	Micro to mini (Right Angled) – 50cm length. Box 1A.	
S-BUS Cable	5-pin JST to S-BUS female – 50cm length. Box 6.	
Telemetry Cable	6-pin JST female to 6-pin DF13 – 50cm length. Box 6.	
Air Unit Power Cable	4-pin JST to XT-60 Male – 50cm length. Box 1B.	
Micro USB Cable	Standard Micro USB cable for upgrading the Air Unit software. The same cable can be used for both Air and Ground Units. Box 6.	
SBUS/CAN bus cable	5-pin JST to S-BUS female and to CAN bus female to CAN bus male. Box 5.	

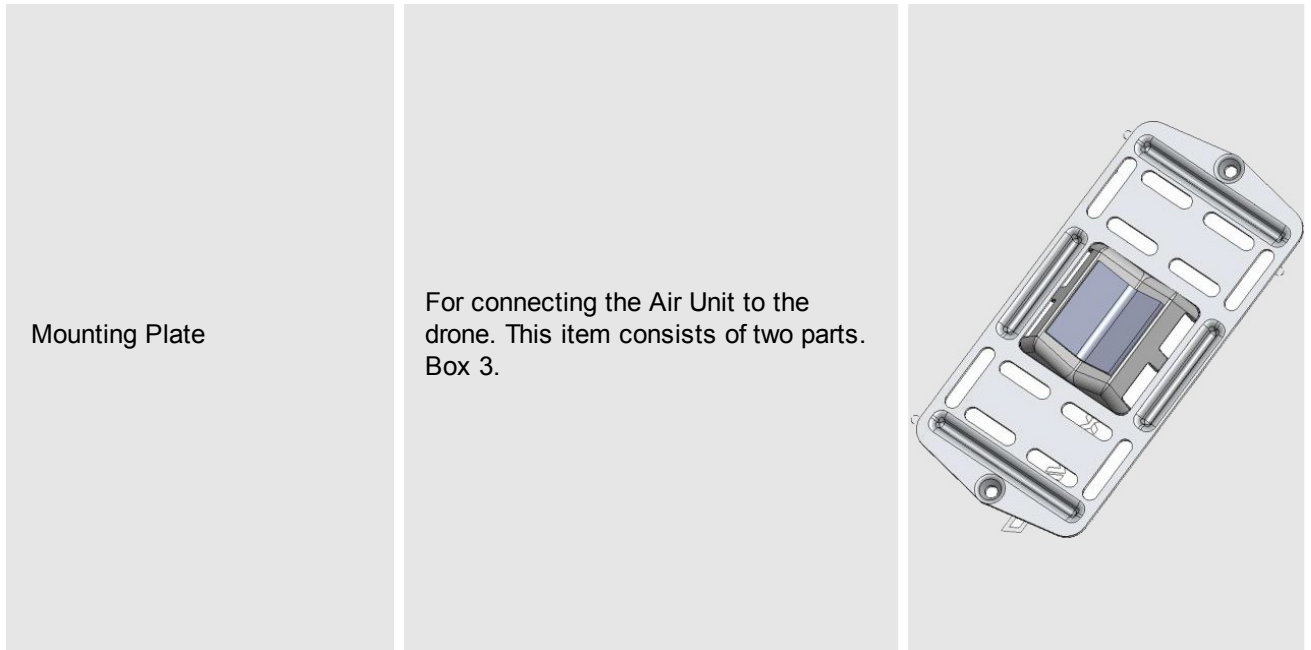

Note: For information about additional accessories, go to www.amimon.com .

CONNEX Ground Unit (Receiver)

The following figures show both sides of the Ground Unit.

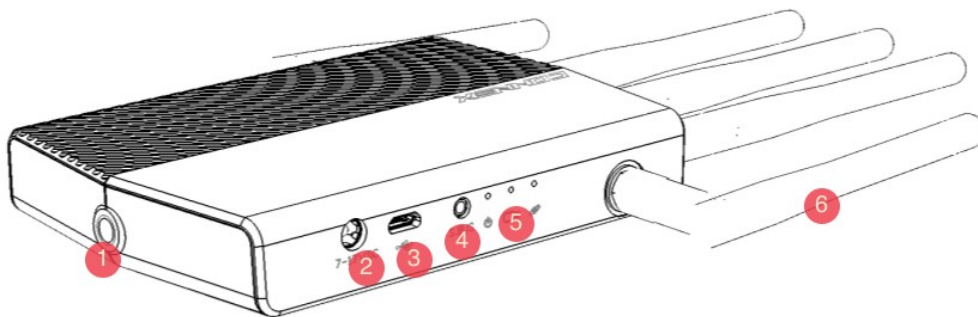

Ground Unit (Receiver) – 1

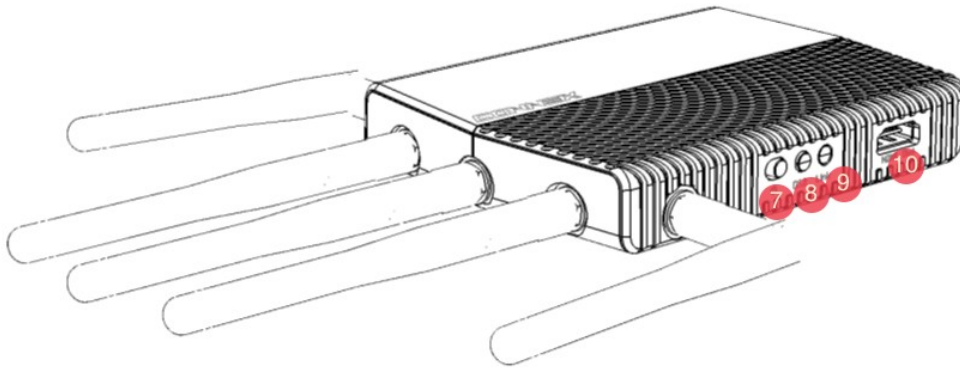



Ground Unit (Receiver) – 2



Key	Name	Description
1	Tripod Mount Hole	Enables you to connect the Ground Unit to a tripod. Connection to a tripod is optional.
2	Power Port	Input rating: 7-17 VDC.
3	Micro USB Port	This port enables upgrade of the Ground Unit software using the CONNEX Management Application for Windows / MAC or for Android devices .
4	S.BUS / PPM Trainer	<p>This port can be connected to the Remote Control trainer port. This port enables you to remotely control the gimbal on the drone using the link between the Ground Unit and the Air Unit.</p> <p>With CONNEX SW version 2.0.x and up, the Ground Unit supports both S.BUS and PPM inputs. (Previously support was limited to S.BUS only.)</p> <p>The bit rate of this control can be configured in the S.BUS Rate field using the CONNEX Management Application for Windows / MAC or for Android devices.</p>
5	LEDs	For a description of the Ground Unit LEDs, refer to Setting Up the CONNEX Ground Unit .
6	Five Rx Antennas Connectors	The five antennas provided need to be screwed onto these connectors.
7	On/Off Switch	Powers the Ground Unit on and off.
8	OSD Button	<p>Enables/disables the OSD display. This display presents a screen of telemetry information collected by the CONNEX system on the monitor connected to the Ground Unit (e.g., Air Unit flight parameters, height, direction, signal strength, and so on). For more information, refer to Ground Unit – On Screen Display (OSD).</p> <p>By default, OSD is enabled (displayed). Pressing this button disables and re-enables OSD.</p>
9	Link Button	The CONNEX system supports up to four Ground Units per Air Unit. The Ground Unit provided out-of-the-box automatically searches for and connects to the Air Unit provided in the same box. The Link button enables you to connect additional Ground Units to the same Air Unit. For details, refer to Multicasting to Multiple Ground Units .
10	HDMI Port	Enables display of the received video. Connect this port to a monitor's HDMI port using the provided standard HDMI cable.

Battery Plate Screws: Four screws for connecting a battery plate are provided on the bottom of the Ground Unit. The battery plate, which is an optional accessory, is not included, and may be purchased from AMIMON's website or authorized resellers.

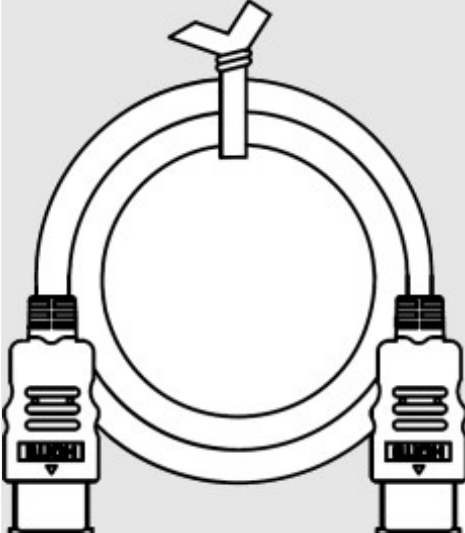
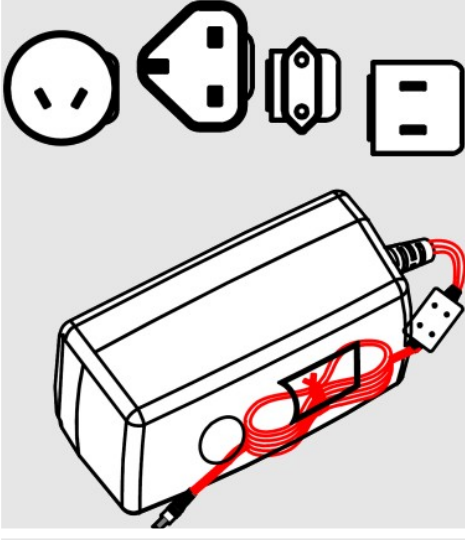
Ground Unit Cables and Antennas

The box number in which each cable is provided is indicated in the table below.

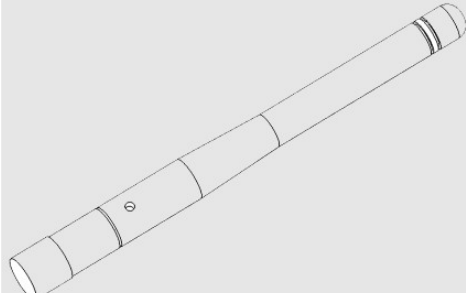
Name	Description	
Standard HDMI Cable	1.2 meters. Box 7.	
AC Power Adapter and Cable	Four different adapters are provided for indoor use only. Box 5.	
S.BUS Trainer Port Cable	3-pin to Futaba – 1 meter cable. Box 6.	
PPM Cable	PL 2.5mm male to PL3.5mm male. Box 7.	

<p>Rx Antennas</p>	<p>Five 2dbi screw-on antennas. Box 4.</p>	
<p>Micro USB Cable</p>	<p>Standard Micro USB cable for upgrading the Ground Unit software.</p> <p>The Micro USB connector connects to the USB port on the Air and Ground Units.</p> <p>The mini USB connector connects to a computer on which the Ground Unit software is installed. Box 6.</p>	
<p>USB to Micro USB Connector</p>	<p>Enables connection of the Air Unit to a tablet or mobile device.</p>	

CONNEX Mini Air Unit (Transmitter)

The following figures show both sides of the Air Unit.

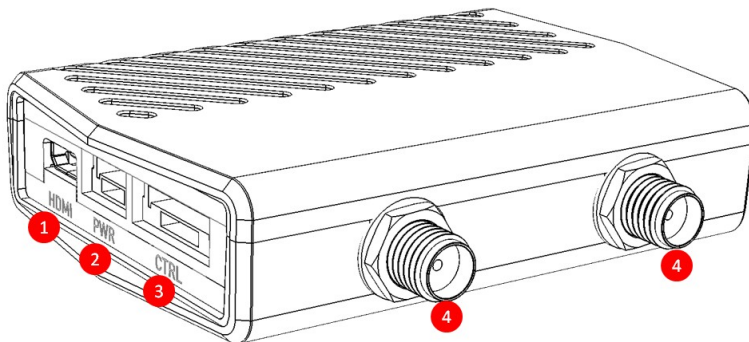

Air Unit (Transmitter) – 1

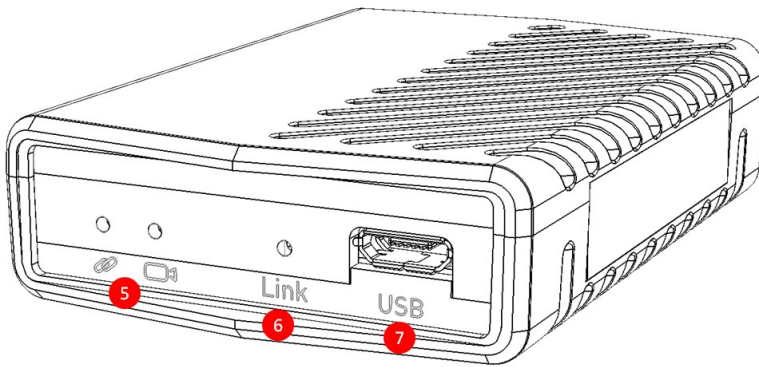







Air Unit (Transmitter) – 2

Key	Title	Description
1	Micro HDMI IN	For receiving video from the camera.
2	Power Connector	Input rating: 8-26 VDC (3-6 cells).
3	S.BUS / CAN bus or S.BUS / MAVLink	<p>I/O port, connecting to the flight controller (CAN bus or MAVLink) and control of the camera Gimbal (S.BUS). The cable for this port can support either of the following options:</p> <ul style="list-style-type: none"> • CAN bus-S.BUS: Allows both CAN bus telemetry input from the A2/NAZA flight controller (to be overlaid on the video via OSD) and S.BUS control output to the S.BUS input on the camera gimbal. • S. BUS-MAVLink/Telemetry: Allows both MAVLink protocol input from Pixhawk/APM ArduPilot flight controller (to be overlaid on the video via OSD) and S.BUS control output to the S.BUS input on the camera gimbal. <p>The flight control data from the flight controller is overlaid on an On Screen Display (OSD). Telemetry information includes flight mode, number of connected GPS satellites, speed, height and more. To receive telemetry data on the Ground Unit, the Air Unit should be connected to the drone’s telemetry port. For more information, refer to Supported Remote Controls, Gimbals and Telemetry Flight Controllers .</p> <p>S.BUS properties can be configured using the CONNEX Management Application for Windows / MAC or for Android devices.</p> <p>NOTE : AMIMON recommends using the CONNEX link for Gimbal control ONLY and NOT for full drone control.</p> <p>Important:</p> <ul style="list-style-type: none"> • The CAN bus port and USB port (for firmware upgrade) should not be connected at the same time. • Do not connect the S.BUS/CAN bus cable under voltage.

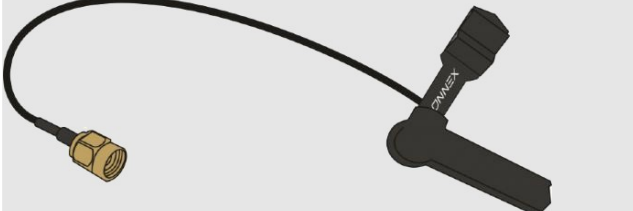
4	Tx Cable Antenna Ports	Two ports for connecting lightweight 2dbi cable antennas.
5	LEDs	For a description of the Air Unit LEDs, refer to LED Behavior .
6	Link Button	The Air Unit is provided pre-paired (preregistered) with the Ground Unit that comes in the box. The Link button can be used to pair up to three additional Ground Units with the same Air Unit. For a description of how to pair additional Ground Units with an Air Unit, refer to Multicasting to Multiple Ground Units .
7	Micro USB Port	This port enables configuration and upgrade of the Air Unit software using the CONNEX Management Application for Windows / MAC or for Android devices .

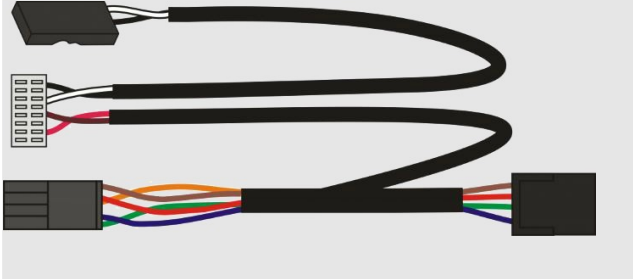
Air Unit Accessories

Cables and accessories for the Air Unit are described in the table below.

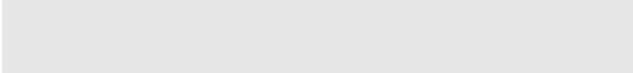
Name	Description	
Tx Cable Antennas and Mounting Accessories	Two flat lightweight 2dbi cable antennas pre-connected to a mounting accessory.	
Micro to Micro HDMI Cable	Micro to Micro (Right Angled) – 50cm length.	
SBUS - CAN bus Cable / SBUS - MAVLink Telemetry Cable	Provides SBUS to gimbal control connection and telemetry for CAN bus flight controllers. The CAN bus end of the cable is equipped with an additional female CAN bus connector.	
	Provides SBUS to gimbal control connection and telemetry connector for MAVLink flight controllers.	
Air Unit Power Cable	4-pin JST to XT-60 Male – 50cm length.	
Micro USB Cable	Standard Micro USB cable for upgrading the Air Unit software. The same cable can be used for both Air and Ground Units.	
USB to Micro USB Connector	Enables connection of the Air Unit to a tablet or mobile device.	
Mounting accessories	Velcro mount and three plastic ties.	

Note: For information about additional accessories, go to www.amimon.com .

CONNEX Mini Ground Unit (Receiver)

The following figures show both sides of the Ground Unit.

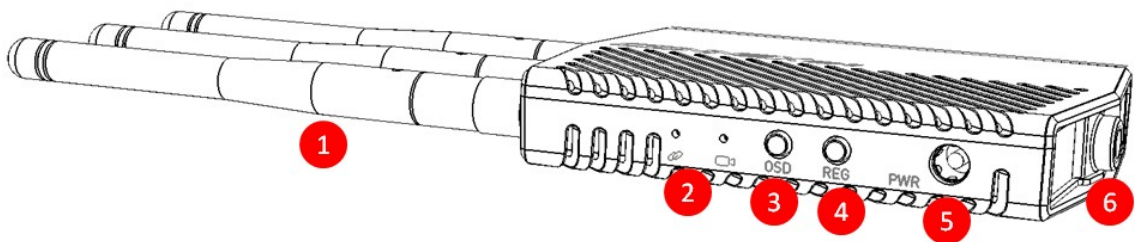

Ground Unit (Receiver) – 1

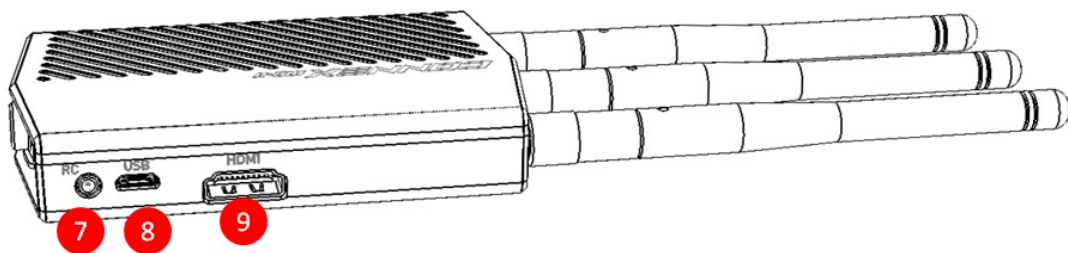



Ground Unit (Receiver) – 2



Key	Name	Description
1	Three Rx Antennas Connectors	The three antennas provided need to be screwed onto these connectors.
2	LEDs	For a description of the Ground Unit LEDs, refer to LED Behavior .
3	OSD Button	Enables/disables the OSD display. This display presents a screen of telemetry information collected by the CONNEX mini system on the monitor connected to the Ground Unit (e.g., Air Unit flight parameters, height, direction, signal strength, and so on). For more information, refer to Ground Unit – On Screen Display (OSD) . By default, OSD is enabled (displayed). Pressing this button disables and re-enables OSD.
4	Link Button	The CONNEX mini system supports up to four Ground Units per Air Unit. The Ground Unit provided out-of-the-box automatically searches for and connects to the Air Unit provided in the same box. The Link button enables you to connect up to three additional Ground Units to the same Air Unit. For details, refer to Multicasting to Multiple Ground Units .

5	Power Port	Input rating: 8-26 VDC.
6	Tripod Mount Hole	Enables you to connect the Ground Unit to a tripod. Connection to a tripod is optional.
7	S.BUS / PPM Trainer	<p>This port can be connected to the Remote Control trainer port. This port enables you to remotely control the gimbal on the drone using the link between the Ground Unit and the Air Unit. The Ground Unit supports both S.BUS and PPM inputs.</p> <p>The bit rate of this control can be configured in the S.BUS Rate field using the CONNEX Management Application for Windows / MAC or for Android devices.</p>
8	Micro USB Port	This port enables configuration and upgrade of the Ground Unit software using the CONNEX Management Application for Windows / MAC or for Android devices .
9	HDMI Port	Enables display of the received video. Connect this port to a monitor's HDMI port using the provided Standard HDMI cable.

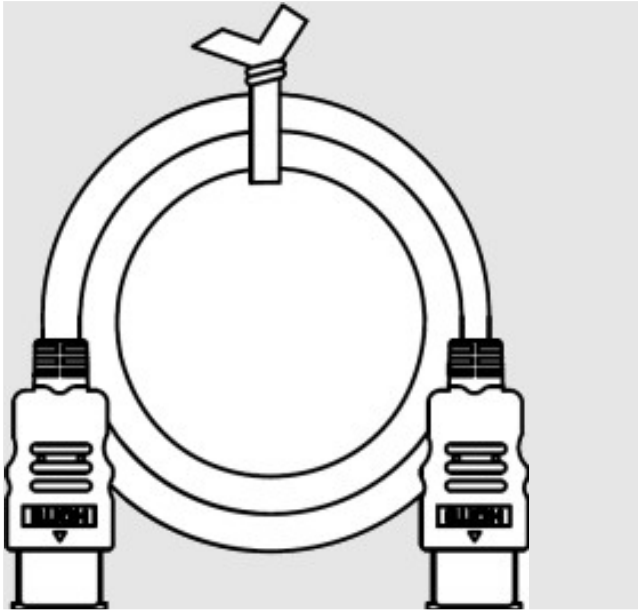
Ground Unit Cables and Antennas

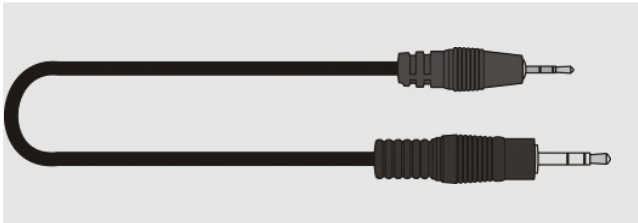
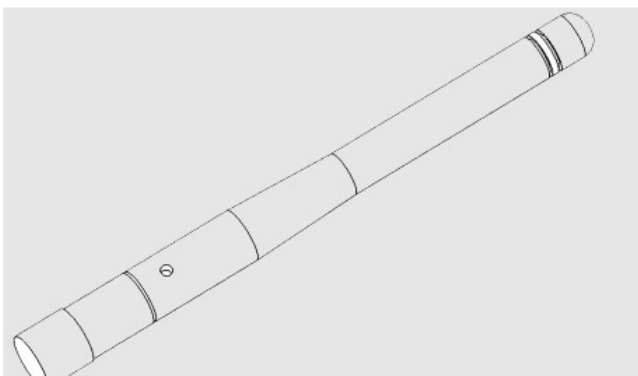
Cables and accessories for the Ground Unit are described in the table below.

Name	Description	
Standard HDMI Cable	1.2 meters.	
Power Connector	DC plug to XT-60 Male – 50cm length	
S.BUS Trainer Port Cable	3-pin to Futaba – 1 meter cable.	
PPM Cable	PL 2.5mm male to PL3.5mm male.	
Rx Antennas	Three 2dbi screw-on antennas.	

<p>Micro USB Cable</p>	<p>Standard Micro USB cable for upgrading the Ground Unit software.</p> <p>The Micro USB connector connects to the USB port on the Ground Unit.</p> <p>The mini USB connector connects to a computer on which the Ground Unit software is installed.</p>	
<p>USB to Micro USB Connector</p>	<p>Enables connection of the Ground Unit to a tablet or mobile device.</p>	

Getting Started - Air and Ground Units

Before you begin, verify that the Air Unit and Ground Unit you are working with are designed for the same product. A CONNEX Air Unit will not link with a CONNEX mini Ground Unit, and vice versa.

The Air and Ground Units provided in the same box are preconfigured to automatically search for and connect to each other.

To get started with the Air Unit:

1. Set up the Air Unit, as described in [Setting Up the CONNEX Air Unit](#) or [Setting Up the CONNEX mini Air Unit](#).
2. The Air Unit can be configured to transmit video downlink to up to three additional Ground Units, as described in [Multicasting to Multiple Ground Units](#).

To get started with the Ground Unit:

- Set up the Ground Unit, as described in [Setting Up the CONNEX Ground Unit](#) or [Setting Up the CONNEX mini Ground Unit](#).

The monitor connected to the Ground Unit then automatically displays video and an overlay of information received from the Air Unit, as described in [Ground Unit – On Screen Display \(OSD\)](#).

3

Safety Instructions and Maintenance

This chapter presents:

- [Safety Symbols and Instructions](#)
- [Potential Hazards](#)

Safety Symbols and Instructions

Safety Symbols



High Voltage Sign: Warns the user of the presence of uninsulated dangerous voltage within the product enclosure, which may be of sufficient magnitude to constitute a risk.



General Warning Sign: Warns the user of the presence of important operating and maintenance (servicing) instructions.



Safety Instructions

- Do not open the Air Unit or Ground Unit enclosures. There are no user-serviceable parts inside. Refer servicing to qualified service personnel only. The use of controls, adjustments or procedures other than those specified in this user guide may result in exposure to shock and/or electrical or mechanical hazards.
- Do not immerse the units in water.
- Do not block the air ventilation openings.
- Always disconnect a unit's power by pulling the mains plug.
- Clean with a dry cloth only.
- Keep powered on units at least 20 cm away from your body.
- Do not expose the units to moisture or excessive heat. Unit operating temperature is 32–113°F or 0–45°C.
- Unplug the units during lightning storms and during long periods of storage.
- For CONNEX only - The provided power supply is for indoor use only.
- Use only the supplied accessories or those recommended on the AMIMON website. Accessories (including cables) must not be replaced, as this may affect performance or functionality, or damage the unit. We highly recommend that you use the provided AMIMON cables. If an alternate cable is used, make sure that it is of the highest quality.
- Do not use the product if there is any physical damage to the enclosure.
- For CONNEX only - It is normal for the product to become slightly hot during use. However, if the enclosure's temperature becomes too hot to touch, turn the product off and contact support. The internal fan of the Air

Unit (transmitter) should work at all times when power is on.

- Do not let the product come into contact with corrosive materials.
- Do not let the product come into contact with fire.

Potential Hazards



Potential Hazards

The CONNEX and CONNEX mini Air Units and Ground Units contain HD wireless video module devices that should be operated according to the same rules and limitations applicable to normal HD wireless video module devices. Do not operate the units in environments that may be susceptible to radio interference resulting in danger, specifically:

- **Areas where prohibited by law:** Follow any special rules and regulations and obey all signs and notices. Always ensure that the unit is turned off (the power switch is not lit) when instructed to do so or whenever it may cause interference or danger.
- **Where explosive atmospheres may be present:** Do not operate the CONNEX and CONNEX mini™ units in any area where a potentially explosive atmosphere may exist. Sparks in such areas could cause an explosion or fire, resulting in bodily injury or even death. Be aware and comply with all signs and instructions.
- **It is not advisable to operate the CONNEX or CONNEX mini units while at a refueling point or service station:** Users are reminded to observe restrictions on the use of radio equipment in fuel depots (fuel storage and distribution areas), chemical plants or where blasting operations are in progress.
- **Areas with a potentially explosive atmosphere are often, but not always, clearly marked:** Potential locations can include gas stations, below deck on boats, chemical transfer or storage facilities, vehicles using liquefied petroleum gas (such as propane or butane), areas where the air contains chemicals or particles (such as grain, dust or metal powders), and any other area where it would normally be advisable to turn off a vehicle's engine.
- **Near medical and life support equipment:** Do not operate the CONNEX or CONNEX mini units in any area where medical equipment or life support equipment is in use, or near any equipment that may be susceptible to any form of radio interference. As the CONNEX / CONNEX mini unit may transmit signals that could interfere with this equipment, the host communications device must be turned off in such areas.

For more information, visit www.AMIMON.com .

4

Specifications and Supported Features

This chapter presents:

- [Technical Specifications](#)
- [Supported Remote Controls, Gimbals and Telemetry Flight Controllers](#)
- [Supported Resolutions](#)

Technical Specifications

The following table presents the technical specifications for CONNEX and CONNEX mini.

	CONNEX		CONNEX mini	
Transmission Distance Outdoor	Up to 1,000m/3,000 ft. (LoS)		Up to 500m/1,500 ft. (LoS)	
Transmission Delay	Zero [Less than 1 msec.]			
Radio Frequency	5.1-5.8 GHz, according to regional regulations			
Channel Selection	Automatic frequency selection [AFS]			
Video Formats	1080p60/59.94, 1080p/50, 1080i60/59.94, 1080i/50, 1080p30/29.97, 1080p24/23.98, 720p60/59.94, 720p/50, 480i60/59.94, 480p60/59.94, 576i50, 576p/50			
Multicast Mode	Up to 4 receivers with no delay or quality degradation. [Requiring extra Ground Unit(s)]			
OSD Support	MAVLink (3DR) and CAN bus (DJI) Telemetry			
Gimbal Control	Ground unit PPM or SBUS trainer port input / Air Unit SBUS port output			
Encryption	AES-128 & RSA 1024 for key exchange			
Operating Temperature	0-45°C			
Regulation	CE, FCC, MIC			
	CONNEX		CONNEX mini	
	Air Unit	Ground Unit	Air Unit	Ground Unit
Video Interface	mini HDMI	HDMI (Type A)	Micro HDMI	HDMI (Type A)
Antenna Connectors	MMCX (x2)	RP SMA (x5)	RP SMA (x2)	RP SMA (x3)
Power Connector	4-pins	DC round	4-pins	DC round
Power Input	8-26V (3S-6S)	7-17V	8-26V (3S-6S)	8-26V (3S-6S)
Dimensions (mm)	103 x 63.6 x 15.6	129 x 89 x 20	66 x 45 x 15	100 x 71 x 17
Weight	120 grams	290 grams	60 grams	120 grams

Supported Remote Controls, Gimbals and Telemetry Flight Controllers

This section lists the Air Unit camera gimbals and remote controls that are supported by CONNEX and CONNEX mini.

Supported Air Unit Camera Gimbals (partial list, for pre-tested models)

- DJI - Zenmuse Z15-GH4 (HD), Z15-GH3, Z15-BMPCC, Z15-5D, Z15-5D III (HD)
- DJI - Ronin, Ronin-M
- FreeFly Movi M5
- Tarot T-2D

Supported Remote Controls (partial list, for pre-tested models)

** Please note that any RC unit that outputs PPM protocol over its trainer port can be supported only with CONNEX SW version 2.0.x and higher.

- Futaba T14GS
- Futaba FX-22
- Futaba T18MZ
- Futaba FX-32
- Futaba T14SG
- Futaba T10J
- DJI NPVT581
- DJI SR6
- Spektrum DX7S
- JR XG6

Supported Flight Controllers for Telemetry (partial list, for pre-tested models)

- DJI A2
- DJI NAZA
- 3DR Pixhawk
- 3DR APM
- 3DR ArduPilot

Supported Resolutions

The following table lists the video formats and resolutions supported by CONNEX and CONNEX mini.

Video Format Timings	Format Name	CONNEX		CONNEX mini	
		40MHz	20MHz	40MHz	20MHz
720(1440) x 480i @ 59.94/60Hz	480i	Yes	Yes	Yes	N/A
640 x 480p @ 59.94/60Hz	480p	Yes	Yes	Yes	N/A
720 x 480p @ 59.94Hz		Yes	Yes	Yes	N/A
720 x 480p @ 60Hz		Yes	Yes	Yes	N/A
720(1440) x 576i @ 50Hz	576i	Yes	Yes	Yes	N/A
720 x 576p @ 50Hz	576p	Yes	Yes	Yes	N/A
1280 x 720p @ 50Hz	720p	Yes	Yes	Yes	N/A
1280 x 720p @ 59.94/60Hz		Yes	Yes	Yes	N/A
1920 x 1080i @ 50Hz	1080i	Yes	No	Yes	N/A
1920 x 1080i @ 59.94/60Hz		Yes	No	Yes	N/A
1920 x 1080p @ 23.98/24Hz	1080p	Yes	Yes	Yes	N/A
1920 x 1080p @ 29.97/30		Yes	Yes	Yes	N/A
1920 x 1080p @ 50Hz		Yes	No	Yes	N/A
1920 x 1080p @ 59.94/60Hz		Yes	No	Yes	N/A
PsF		No	No	No	N/A

5

Setting Up CONNEX

This chapter presents:

- [Setting Up the CONNEX Ground Unit](#)
- [Setting up the CONNEX Air Unit](#)
- [Mounting the Air Unit Antenna Accessories](#)
- [Connecting the Telemetry/MAVLink Port](#)
- [Controlling the Drone Camera Gimbal](#)

Recommendations and Best Practices

This chapter presents:

- [Placement Guidelines – Air Unit Cable Antennas](#)
- [Placement Guidelines - Ground Unit](#)

Placement Guidelines – Air Unit Cable Antennas

This section describes recommended guidelines and best practices for optimal placement of the Air Unit vertical cable antennas.

- **Antennas Should Face the Ground:** Both Air Unit cable antennas must be placed on the drone so that the antennas are pointing to the ground (vertical) when the drone is in flight. For example, as shown below:

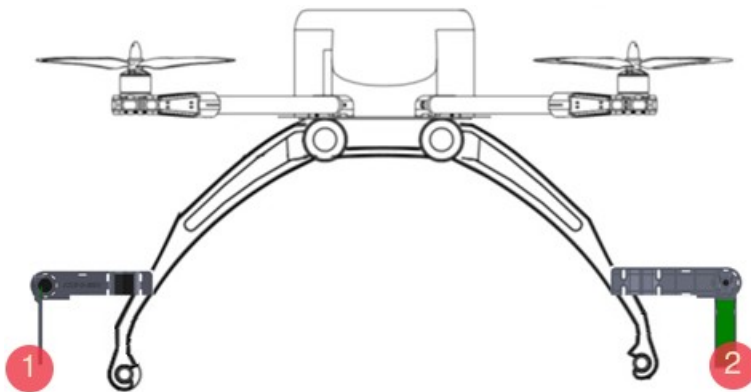

Antennas Should Be Placed so That They Point to the Ground

Key	Description
1	Vertical Antenna
2	Vertical Antenna

- **Avoid Obstacles between the Antennas and the Ground Unit:** Place the Air Unit cable antennas as low as possible in the drone in order to avoid line of sight obstacles between the antennas and the Ground Unit while the drone is flying.
- **Avoid Interference:** Place the Air Unit cable antennas as far away as possible from other transceiver devices on the drone, especially from a transmitter in the 5 GHz band.

- **Avoid Proximity to Metal Objects:** The antennas must be at least 7 cm away from any metal object, such as the landing gear or a battery. For example, do not tie the antenna directly onto the landing gear, even if it is made of carbon. The [mounting accessories](#) provided enable you to attach the antennas while maintaining the required distance.
- **Place the Antennas so That They Are Facing Outwards:** Do not place the antennas facing the inside of the drone structure.
- **Place the Antennas so That They Are Still Facing the Ground When the Drone Takes Flight**
- **Place the Antennas so That They Are Vertical (Pointing to the Ground), but Perpendicular:** The following diagram shows an optimal placement option in which both antennas are facing different directions (perpendicular), achieving a 90° angle between them.

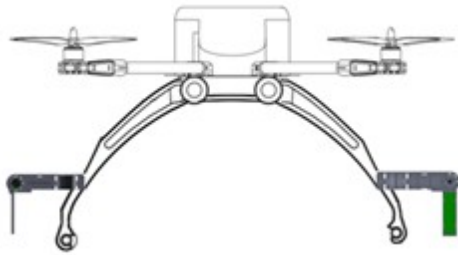

Optimal Placement Examples

Note: In order to achieve optimal transmission, you must also follow the Ground Unit placement requirements described in [Placement Guidelines](#).

Placement Guidelines – Ground Unit

This section describes mandatory requirements and best practices for optimal placement of the Ground Unit and its antennas.

- **Place the Ground Unit as High as Possible:** Place the Ground Unit on a tripod, pole or table so that it is as high as possible. A height of 2 meters is optimal.
- **Place the Ground Unit Antennas Facing the Air Unit:** Place the Ground Unit so that its antennas are facing upwards in the general direction in which the drone will be flying.

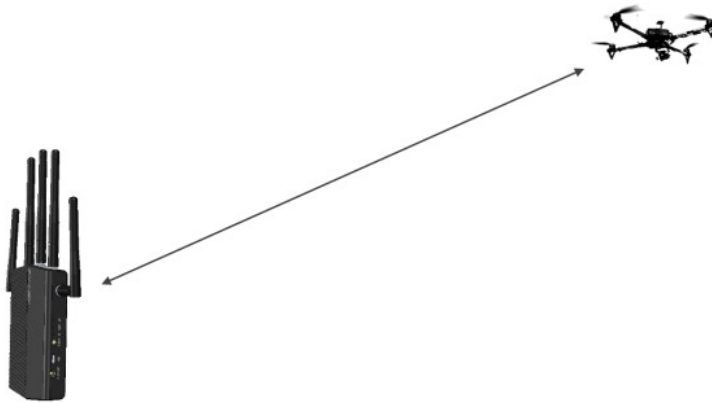

Ground Unit Antennas Facing the Drone

- **Avoid Interference:** Place the Ground Unit cable antennas as far away as possible from other transceiver devices, especially transmitters in the 5 GHz band.

Setting Up the CONNEX Ground Unit

We highly recommend that you use the provided AMIMON accessories and cables. If alternate products are used, make sure that they are of the highest quality.

To set up the CONNEX Ground Unit:

1. Refer to the [Placement Guidelines](#) for a description of mandatory requirements and best practices for optimal placement of the Ground Unit and its antennas.
2. Screw on the five provided antennas to the five Ground Unit antenna connectors, as shown below:

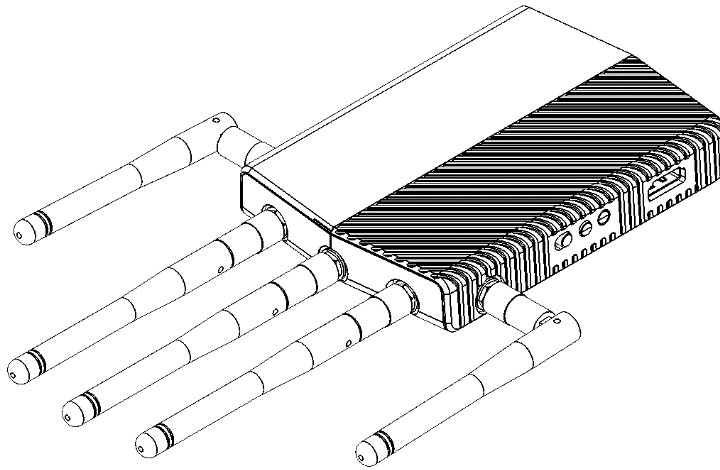

Connecting the Ground Unit Antennas – Box 4

3. Enable display of the received video by connecting the provided **Standard HDMI cable** (Box 7) from the Ground Unit **HDMI port** to the monitor's **HDMI port** (click [here](#) for details).
4. Connect the provided power AC adapter (Box 5) to the power port on the Ground Unit labeled **7-17-VDC** (click [here](#) for details), and connect the other end to a power source. The provided power AC adapter should be used indoors only.

Verify that all three LEDs on the Ground Unit light up (On), as described in the tables below.



Ground Unit – Power LED

- | | |
|----------------|--|
| On (White) | The Ground Unit is powered On and the unit's On/Off switch is on (click here for details). |
| Off | No power is being supplied to the Ground Unit. |
| Blinks Quickly | Indicates a system error. |



Ground Unit – Video LED

- | | |
|-----------|--|
| On (Blue) | Live video is being transmitted from the Ground Unit (i.e., the signal is being received from the Air Unit). |
| Off | The Ground Unit is powered down, or there is no video lock on the Air Unit. |



Ground Unit – Network LED

	<p>A link has been established to the Air Unit, meaning that the Ground Unit is receiving video transmission from the Air Unit. The Network LED displays one of three colors to indicate the strength of the signal received by the Ground Unit, as follows:</p>
On (Blue)	<ul style="list-style-type: none">· Red: Poor· Green: Fair· Blue: Excellent
Off	No paired devices.
Blinks Quickly	The Ground Unit is pairing with an Air Unit, or the Air Unit has gone out of range of the Ground Unit.
Blinks Slowly	The Ground Unit is searching for an Air Unit with which to establish a link.

Setting Up the CONNEX Air Unit

Set up the CONNEX Air Unit (transmitter) and connect it to the drone, as described in this section.

We highly recommend that you use the provided AMIMON accessories and cables. If alternate products are used, make sure that they are of the highest quality.

To set up the CONNEX Air Unit:

1. Assemble the Air Unit/drone mounting plate:

If attaching the Air Unit to a flat surface on the drone, perform the following:

- Place the Air Unit in the center of the provided mounting plate, on the side with the mounting plate bumps protruding.
- Use screws or plastic ties to secure the Air Unit to the mounting plate. You can thread the plastic ties through any of the holes on the mounting plate.

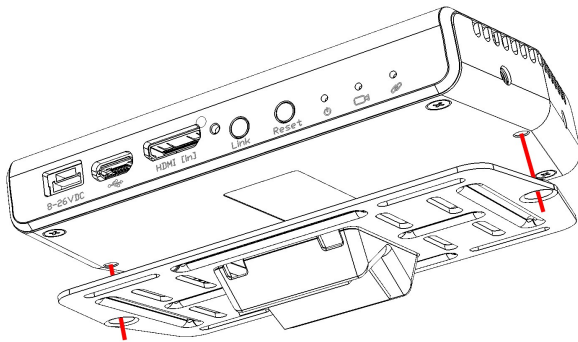

Attaching the Air Unit to the Mounting Plate

If attaching the Air Unit to a bar on the drone, perform the following before attaching the Air Unit to the mounting plate:

- A clear plastic holder is provided to help attach the mounting plate to a bar or to the landing gear of the drone. The square plastic insert can be placed in the opening in the center of the mounting plate either horizontally or vertically, according to how you want to position the mounting plate relative to the bar to which you are attaching it.
- Insert the plastic holder into the opening in the square center of the mounting plate, as shown below:

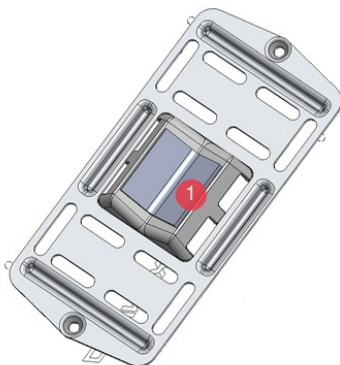

Connecting the Mounting Plate to a Bar on the Drone

1 = Square plastic insert for attaching the mounting plate to a bar

2. Attach the mounting plate (with the Air Unit attached to it as described above) to the drone using screws or plastic ties. Typically, it can be placed on the bottom of the drone. Make sure that the Air Unit's ventilation openings are not obstructed.
3. Attach the Air Unit cable antenna mounting accessories to the drone. Make sure the mounting accessories are placed close enough to the Air Unit for the cable antennas to reach the Air Unit's antenna ports.

IMPORTANT! For optimal performance, carefully read and then implement the guidelines provided in [Placement Guidelines - Air Unit Cable Antennas](#). These guidelines describe the best mounting options for the Air Unit cable antenna options.

4. Connect the two Air Unit flat cable antennas to the two Air Unit cable antenna ports, as shown below:

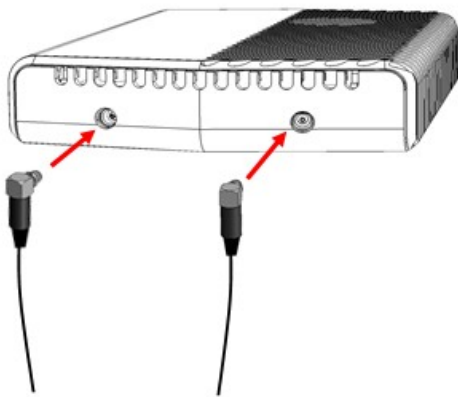

Connecting the Antennas to the Air Unit

5. Connect the provided Micro to mini HDMI cable from the HDMI IN port on the Air Unit to the camera. The right side of this cable goes into the Air Unit HDMI IN port. The left side of this cable goes into the drone's camera.



Connecting the Air Unit HDMI Cable – Box 1A Micro to mini HDMI

Close the HDMI Connector Screw (to the right of the HDMI IN port) to stabilize the connected HDMI cable to the Air Unit.

6. Connect the provided Air Unit Power cable to the power port on the Air Unit. The right side of this cable (as shown below) goes into the Air Unit power port labeled 8-26-VDC.



The left side of this cable goes to the battery.

7. Connect the other end of the provided Air Unit power cable to the power source (battery). Use an 8-26-VDC voltage battery.

Verify that the Air Unit Power LED  lights up. (See the Air Unit Power LED table below.)

8. The Air Unit automatically connects with the powered on Ground Units that are paired with this Air Unit. A connection is established between the Air and Ground Units regardless of whether video is transmitted on the wireless link, as follows:
 - o If video is transmitting, the Ground Units display the video.
 - o If video is not transmitting, the Ground Units display the following message upon linking to the Air Unit: *No video detected. Please check video source.*

The Air Unit's video and transmission status is indicated by its LEDs, as described below.
9. [Optional] To display information received from the drone's flight controller overlaid on the video on the Ground Unit monitor, refer to [Connecting the Telemetry Port](#) .



Air Unit - Power LED

- | | |
|----------------|---|
| On (White) | The Air Unit is powered on. |
| Off | No power is being supplied to the Air Unit. |
| Blinks Quickly | Indicates a system error. |



Air Unit – Video LED

- | | |
|----------------|--|
| On (White) | The video signal from the camera is locked, meaning that it is being correctly received by the Air Unit from the camera. |
| Off | The video from the camera is not locked, meaning that the Air Unit is not receiving the video from the camera. |
| Blinks Quickly | The Air Unit is powered down or the camera is transmitting a video resolution that is not supported by the Air Unit. (For a list of supported resolutions, click here.) |



Air Unit – Network LED

- | | |
|----------------|---|
| On (White) | A link has been established to the Ground Unit. |
| Off | The Air Unit is not broadcasting because it has not recognized any Ground Units with which it was paired previously. |
| Blinks Quickly | The Air Unit is pairing with a Ground Unit, or the Air Unit has gone out of range of the Ground Unit and is searching for it. |
| Blinks Slowly | The Air Unit is establishing a link with a Ground Unit. |

Blinks Very Slowly

The Air Unit is searching for an available frequency on which to transmit.

Note: This may take up to 70 seconds when working outdoors in Japan.

Mounting the Air Unit Antenna Accessories

The Air Unit antenna mounting accessories provide a variety of options for attaching the two provided flat cable antennas to the drone so that they are pointing towards the ground (vertical).



Air Unit Cable Antenna Mounting Accessory – With Flat Cable Antenna – Box 2

Key	Description
1	Antenna
2	Antenna Cable
3	Antenna Clamp
4	Antenna Mounting Screw
5	Antenna Mounting Piece



Front of the Antenna Mount Piece

Key	Description
1	Drone leg/bar is here

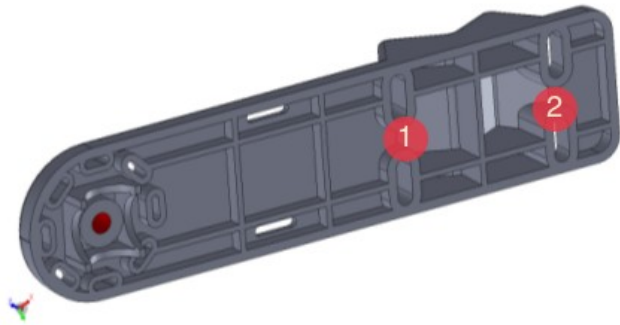

Back of the Antenna Mount Piece

Key	Description
1 + 2	Plastic ties can be threaded through here to attach this to the drone

The Antenna Clamp attaches to the rotary on the Antenna Mounting Piece (shown above) using the provided screw. The Antenna Clamp has two holes through which you can insert the screw to attach it to the Antenna Mounting Piece according to the direction you would like the antenna to point. Once the Antenna Clamp is connected to the Antenna Mounting Piece, you can rotate it in the direction that you require the antenna to point, as shown below:

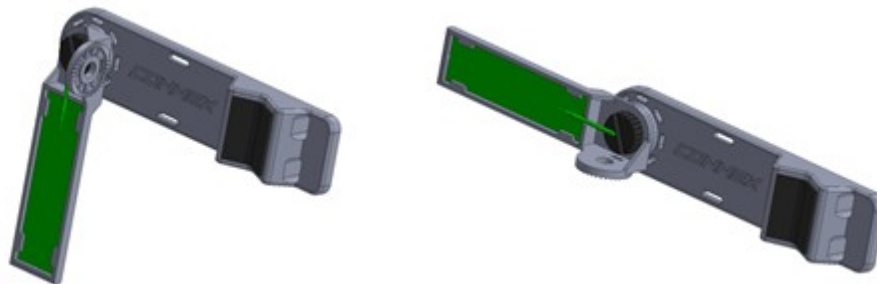

Rotating the Antenna Clamp around the Antenna Mounting Piece

Connecting the Telemetry/MAVLink Port

The following procedure describes how to connect the Air Unit Telemetry/MAVLink port to the drone's flight controller so the Ground Unit monitor can display information received from the drone's flight controller overlaid on the video (such as flight mode, number of connected GPS satellites, speed, height, orientation and more).

To connect the Telemetry port:

- Connect the Air Unit Telemetry port to the drone using the provided Air Unit Telemetry cable.

The right side of this cable goes into the [Air Unit Telemetry port](#).

The left side of this cable goes into the Telemetry port of the flight controller on the drone.



Connecting the Air Unit Telemetry Cable – Box 6

Note: Not all flight controllers are supported. For a list of tested models, refer to [supported flight controllers](#).

Controlling the Drone Camera Gimbal

The CONNEX Gimbal Control feature enables an operator on the ground to control the drone's camera gimbal using various remote controls over the video uplink channel. Only gimbals that can input S.BUS are supported. Gimbal control is supported for up to 1 Km.

This feature is supported only when an Air Unit is paired with a single Ground Unit. Before beginning the procedure below, verify that this is the case by [checking the Ground Units that are registered to the Air Unit](#).

To enable the CONNEX Gimbal Control feature:

1. Connect the Air Unit S.BUS port to the S.BUS or D.BUS port on the camera's gimbal using the provided S.BUS cable (click [here](#) for details).



Connecting the Air Unit S-BUS Cable – Box 6

2. Connect the gimbal remote control's Trainer port to the Ground Unit's S.BUS/PWM/PPM port (see [here](#)) using the S.BUS/PWM/PPM port cable.
3. The default gimbal command transmission bit rate is FASSTest 12CH Mode (6.3m sec). If this bit rate is not supported by the gimbal controller, use the CONNEX Management application to configure the S.BUS Bit Rate manually, as described in [Configuring the Link](#).

The Ground Unit automatically detects the S.BUS/PWM/PPM and transmits the gimbal commands over the wireless return channel to the Air Unit's S.BUS/CTRL port.

For a list of supported remote controls and gimbals, [click here](#).

6

Setting Up CONNEX Mini

This chapter presents:

- [Setting Up the CONNEX mini Ground Unit](#)
- [Setting up the CONNEX mini Air Unit](#)
- [Connecting the CTRL Port for MAVLink Telemetry](#)
- [Connecting the CTRL Port for CAN bus Telemetry](#)
- [Controlling the Drone Camera Gimbal](#)

Setting Up the CONNEX Mini Ground Unit

This section describes how to set up the CONNEX mini Ground Unit (receiver).

We highly recommend that you use the provided AMIMON accessories and cables. If alternate products are used, make sure that they are of the highest quality.

To set up the CONNEX mini Ground Unit:

1. Refer to the [Placement Guidelines](#) for a description of mandatory requirements and best practices for optimal placement of the Ground Unit and its antennas.
2. Screw on the three provided antennas to the three Ground Unit antenna connectors, as shown below:

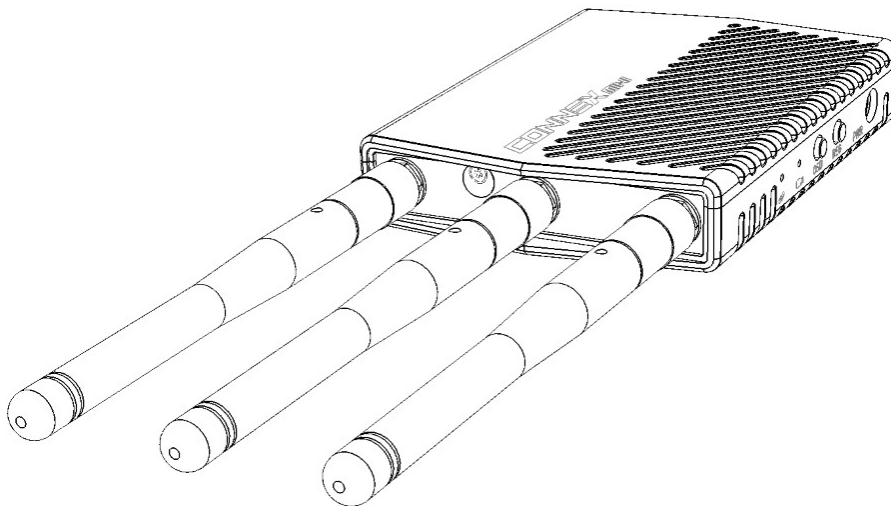

Connecting the Ground Unit Antennas

3. Enable display of the received video by connecting the provided **Standard HDMI cable** from the Ground Unit **HDMI port** to the monitor's **HDMI port**.

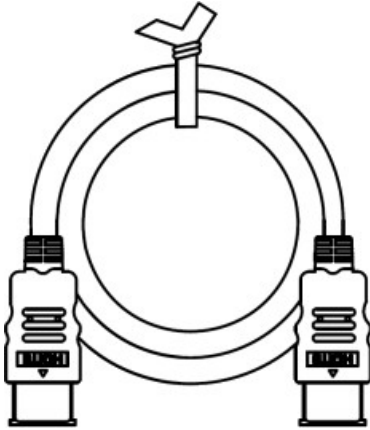

Standard HDMI Cable

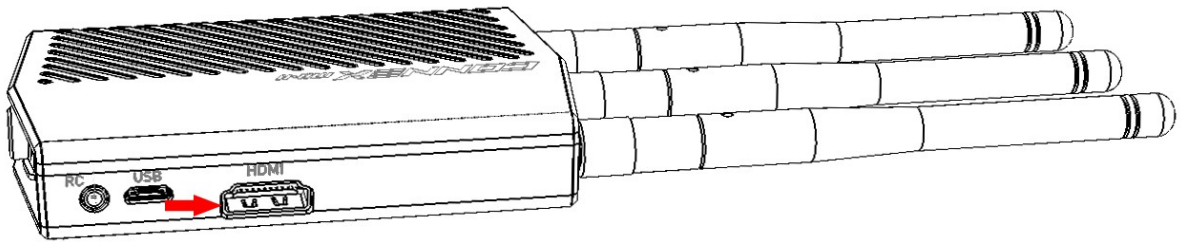

4. Connect the provided power cable to the power port on the Ground Unit labeled **8-26-VDC**, and connect the other end to a power source.

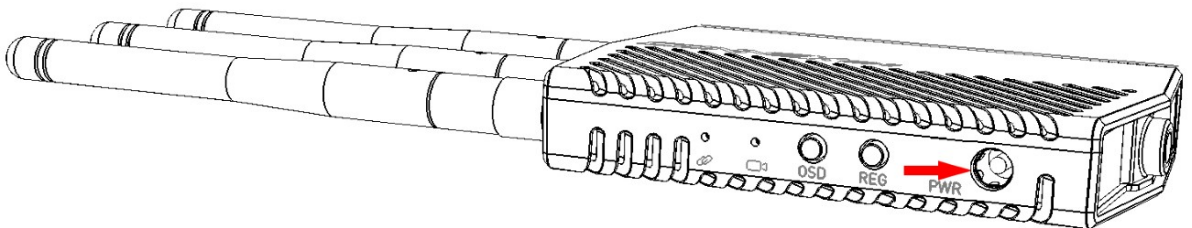

Verify that both LEDs on the Ground Unit light up, as described in the tables below.

LED Behavior

The CONNEX mini features two LED indicators: a Video LED and a Network LED. In normal operating conditions, both LEDs show a constant white color. No power (or low power) is indicated by the LEDs turning off.

When the indicators are blinking quickly (both LEDs), a system error has been detected. In this case, use the CONNEX Management application to [update the software](#), or contact CONNEX support.

The behaviors of each individual LED are described in the tables below.



Ground Unit – Video LED

Solid	The video signal from the camera is locked, (i.e., the signal is being received from the Air Unit).
Blinks Slowly	The video signal from the camera is not locked.
Blinks Quickly	The camera is transmitting a video resolution that is not supported.



Ground Unit – Network LED

Solid	A link has been established to the Ground Unit.
Blinks Quickly	Registration is in progress, or the Ground Unit has gone out of range.
Blinks Slowly	The Air Unit is establishing a link with the Ground Unit.

Setting Up the CONNEX Mini Air Unit

This section describes how to set up the CONNEX mini Air Unit (transmitter) and connect it to the drone.

We highly recommend that you use the provided AMIMON accessories and cables. If alternate products are used, make sure that they are of the highest quality.

To set up the CONNEX mini Air Unit:

1. Attach the Air Unit to the drone, using the Velcro squares provided. The Air Unit may be mounted to a bar or to a flat surface, and then secured with plastic ties.
2. Attach the Air Unit cable antenna mounting accessories to the drone. Make sure the mounting accessories are placed close enough to the Air Unit for the cable antennas to reach the Air Unit's antenna ports.

IMPORTANT! For optimal performance, carefully read and then implement the guidelines provided in [Placement Guidelines - Air Unit Cable Antennas](#). These guidelines describe the best mounting options for the Air Unit cable antenna options.

3. Connect the two Air Unit flat cable antennas to the two Air Unit cable antenna ports, as shown below:

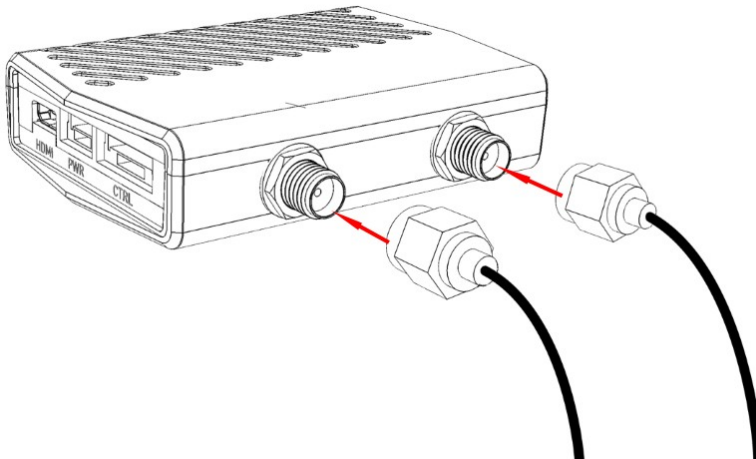

Connecting the Antennas to the Air Unit

Ensure that the antennas are tightly fastened.

4. Connect the provided Micro to Micro HDMI cable from the HDMI IN port on the Air Unit to the camera.



Micro to Micro HDMI Cable

One side of this cable goes into the Air Unit HDMI IN port.

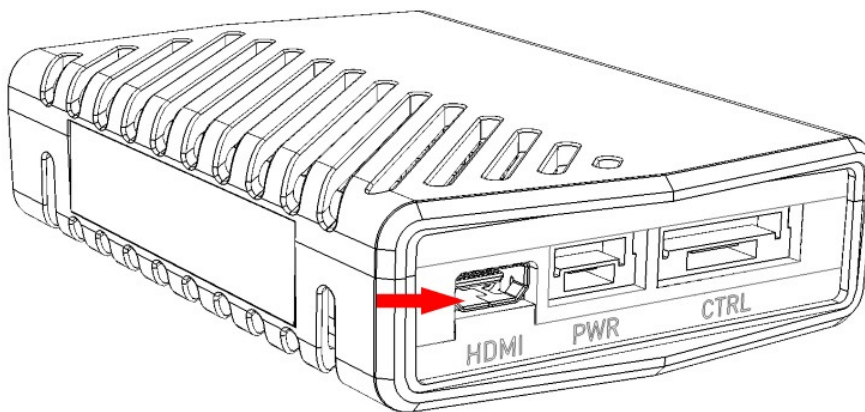

The other side of the cable goes into the drone's camera.

5. Connect the provided Air Unit Power cable to the power port on the Air Unit.



Air Unit Power Cable

The right side of this cable goes into the Air Unit power port.

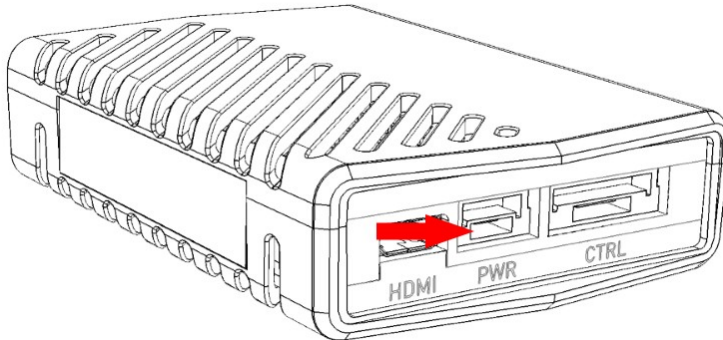

The left side of this cable goes to the battery.

6. Connect the other end of the provided Air Unit power cable to the power source (battery). Use an 8-26VDC voltage battery.
7. The Air Unit automatically connects with the powered on Ground Units that are paired with this Air Unit. A connection is established between the Air and Ground Units regardless of whether video is transmitted on the wireless link, as follows:
 - o If video is transmitting, the Ground Units display the video.
 - o If video is not transmitting, the Ground Units display the message: *Video signal not detected*.
 The Air Unit's video and transmission status is indicated by its LEDs, as described below.
8. [Optional] To display information received from the drone's flight controller overlaid on the video on the Ground Unit monitor, refer to Connecting the CTRL Port [for MAVLink telemetry](#) or [for CAN bus telemetry](#).

LED Behavior

The CONNEX mini features two LED indicators: a Video LED and a Network LED. In normal operating conditions, both LEDs show a constant white color. No power (or low power) is indicated by the LEDs turning off.

When the LED indicator is blinking quickly (in either LED), a system error has been detected. In this case, use the CONNEX Management application to [update the software](#), or contact CONNEX support.

The behaviors of each individual LED are described in the tables below.



Air Unit – Video LED

Solid	The video signal from the camera is locked, meaning that it is being correctly received by the Air Unit from the camera. (This does not necessarily indicate that a link exists.)
Blinks Slowly	The video signal from the camera is not locked, meaning that the Air Unit is not receiving the video from the camera.
Blinks Quickly	The camera is transmitting a video resolution that is not supported by the Air Unit.



Air Unit – Network LED

Solid	A link has been established to the Ground Unit, meaning that video is being transmitted to it (all of the receivers are powered on and in range).
Blinks Quickly	Registration is in progress, or the Air Unit has gone out of range of a Ground Unit and is searching for it.
Blinks Slowly	The Air Unit is establishing a link with a Ground Unit.
Blinks Very Slowly	The Air Unit is searching for an available frequency on which to transmit. Note: This may take up to 70 seconds when working outdoors in Japan.
Off	No broadcasting is occurring.

Connecting the CTRL Port for MAVLink Telemetry

The following procedure describes how to connect the Air Unit CTRL port to the drone's MAVLink flight controller so the Ground Unit monitor can display information received from the drone's flight controller overlaid on the video (such as flight mode, number of connected GPS satellites, speed, height, orientation and more).

CONNEX mini supports both MAVLink telemetry and CAN bus telemetry. Verify that you are using the cable that is relevant for the telemetry option you are using.

To connect the CTRL port for MAVLink telemetry:

- Connect the Air Unit CTRL port to the drone using the provided Air Unit MAVLink Telemetry and S.BUS cable.

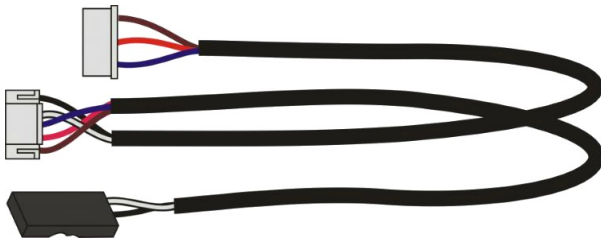

Air Unit Telemetry and S.BUS Cable

The middle connector of this cable goes into the Air Unit CTRL port.

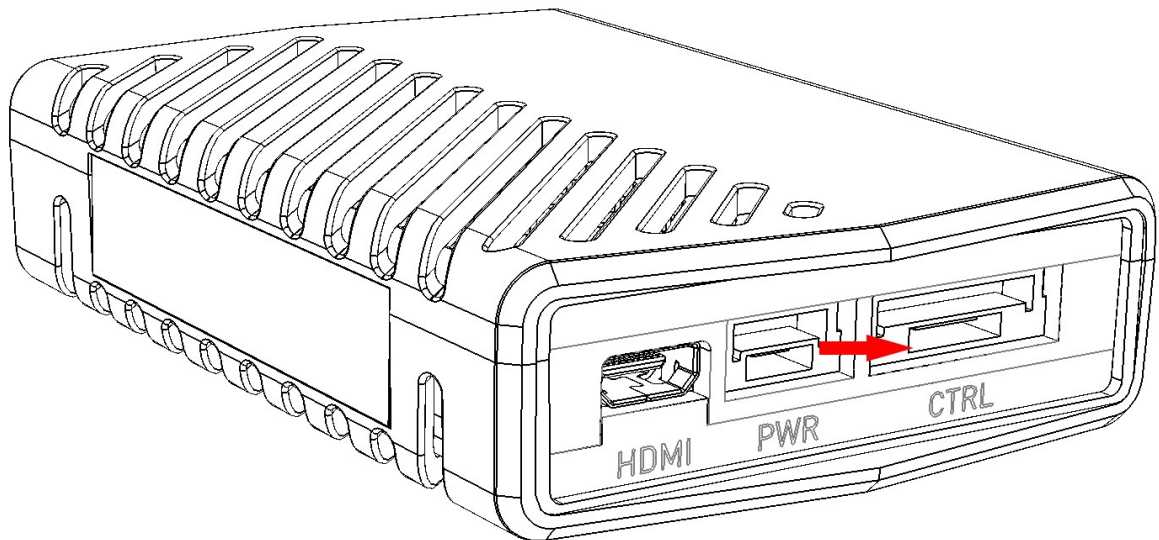

The upper connector of the cable goes into the Telemetry port of the flight controller on the drone.

The lower S.BUS port is used to control the [drone camera gimbal](#).

Note: Not all flight controllers are supported. For a list of tested models, refer to [supported flight controllers](#).

Connecting the CTRL Port for CAN bus Telemetry

The following procedure describes how to connect the Air Unit CTRL port to the drone's CAN bus flight controller so the Ground Unit monitor can display information received from the drone's flight controller overlaid on the video (such as flight mode, number of connected GPS satellites, speed, height, orientation and more).

CONNEX mini supports both MAVLink telemetry and CAN bus telemetry. Verify that you are using the cable that is relevant for the telemetry option you are using.

To connect the CTRL port for CAN bus telemetry:

- Connect the Air Unit CTRL port to the drone using the provided Air Unit CAN bus Telemetry and S.BUS cable.

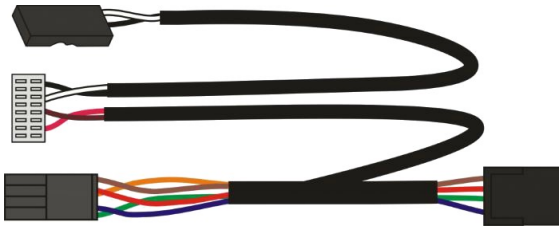

The middle connector of this cable goes into the Air Unit CTRL port.

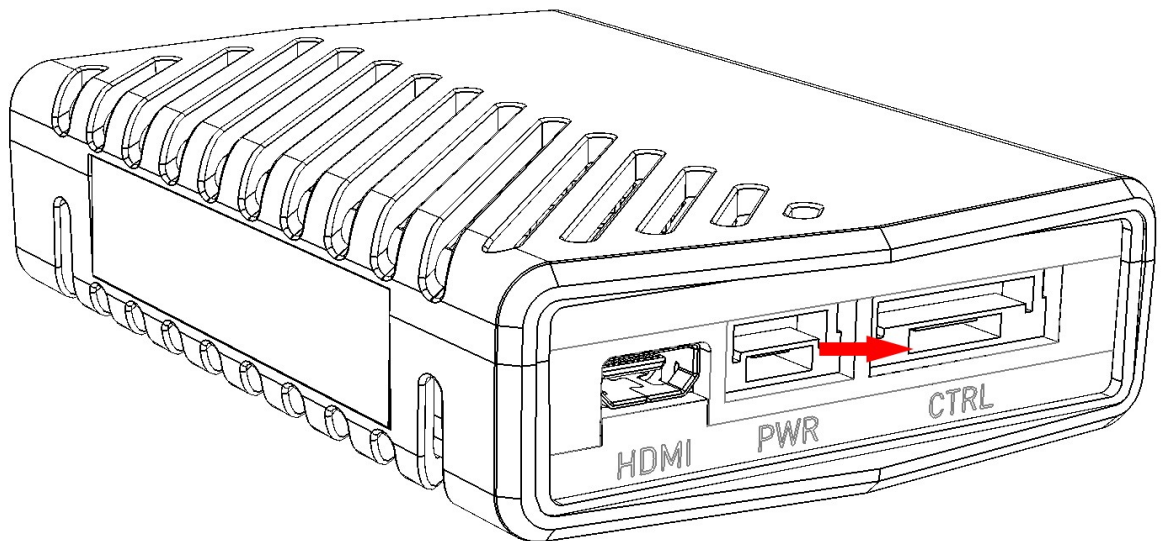

The CAN bus male connector of the cable goes into the Telemetry port of the flight controller on the drone.

The female end is used to connect additional devices to the CAN bus.

The upper S.BUS port is used to control the [drone camera gimbal](#).

Note: Not all flight controllers are supported. For a list of tested models, refer to [supported flight controllers](#).

Controlling the Drone Camera Gimbal

The CONNEX Gimbal Control feature enables an operator on the ground to control the drone's camera gimbal using various remote controls over the video uplink channel. Only gimbals that can input S.BUS are supported. Gimbal control is supported for up to 500 meters.

This feature is supported only when an Air Unit is paired with a single Ground Unit. Before beginning the procedure below, verify that this is the case by [checking the Ground Units that are registered to the Air Unit](#).

To enable the CONNEX Gimbal Control feature:

1. Connect the Air Unit S.BUS/CTRL port to the S.BUS or D.BUS port on the camera's gimbal using the provided Air Unit MAVLink Telemetry and S.BUS cable or Air Unit CAN bus Telemetry and S.BUS cable.

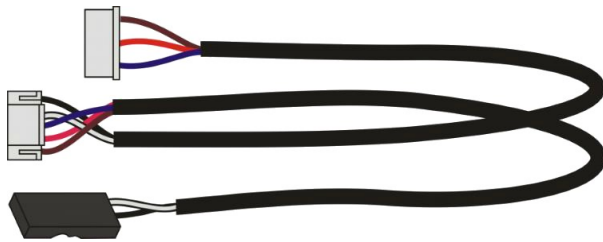

Air Unit MAVLink Telemetry and S.BUS cable



Air Unit CAN bus Telemetry and S.BUS cable

2. Connect the gimbal remote control's Trainer port to the Ground Unit's S.BUS/PWM/PPM port using the S.BUS/PWM/PPM port cable.

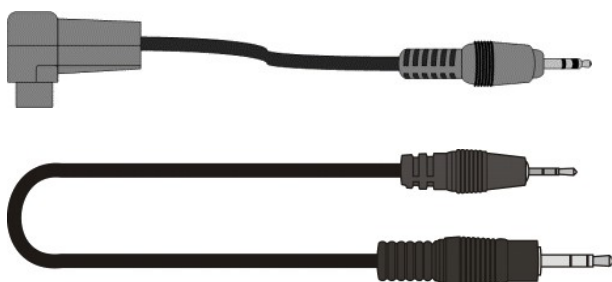

3. The default gimbal command transmission bit rate is FASSTest 12CH Mode (6.3m sec). If this bit rate is not supported by the gimbal controller, use the CONNEX Management application to configure the S.BUS Bit Rate manually, as described in [Configuring the Link](#).

The Ground Unit automatically detects the S.BUS/PWM/PPM and transmits the gimbal commands over the wireless return channel to the Air Unit's S.BUS/CTRL port.

For a list of supported remote controls and gimbals, [click here](#).

7

CONNEX Operational Instructions

This chapter presents:

- [Ground Unit – On Screen Display \(OSD\)](#)
- [Alert and System Messages](#)
- [Multicasting to Multiple Ground Units](#)

Ground Unit – On Screen Display (OSD)

The Ground Unit monitor displays information collected by the CONNEX system overlaid on the video received from the Air Unit. The following types of information can be overlaid on the video:

- Default information
- Additional telemetry information (optional)
- [Alerts and System Messages](#)

Default Information Overlaid on Video

By default, the Ground Unit displays information overlaid on the bottom of the video in a black strip (indicated by the red arrow in the picture below).



OSD ON – Default View

The following information is provided:



Air Unit to Ground Unit video signal strength.



Distance of the Air Unit from the Ground Unit (in meters).



Video resolution captured by the drone camera.



The currently selected frequency option. CONNEX mini systems support automatic frequency only.
When a fixed frequency is selected, the frequency is displayed in MHz.

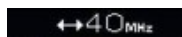

The currently selected bandwidth. CONNEX mini systems support 40 MHz bandwidth only.

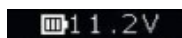

Air Unit power voltage level.



This arrow, which appears when three or more GPS satellites are detected, points in the direction of home. The arrow has eight positions (with 45 degrees between each), and the degrees to the home location is shown below the arrow. (The value is received from the drone's telemetry).

By default, this OSD information is enabled (displayed). Pressing the OSD button (see [here](#)) on the Ground Unit disables (hides) this OSD information. Pressing the button again redisplay it.

Additional Telemetry Information Overlaid on Video

Additional telemetry information can be overlaid on the video received from the drone's flight controller. This information appears in a black strip on the top of the video (indicated by the red arrow in the picture below).



OSD View – With Additional Telemetry Information

The following information is provided:

H: 17_M

Drone height.

YAW: 3

Rotation of the drone around the axis (in degrees), relative to the North.

GS: 3_{M/S}

Ground speed.

UNK

Flight Mode.

The following standard Arducopter flight modes may be displayed:

- STBL (Stabilize)
- ARCO (Arco)
- ALTH (Alt Hold)
- AUTO (Auto)
- GUID (Guided)
- LOIT (Loiter)
- RTL
- CIRC (Circle)
- POS (Position)
- LAND
- DRFT (Drift)
- SPRT (Sport)
- UNK (Unknown)

7

Number of detected GPS satellites.

23.8V

Drone Battery Charge.

The additional telemetry information is displayed when:

- The drone has a [supported flight controller](#).
- The Air Unit Telemetry/MAVLink/CTRL port is connected to the drone's flight controller, as described in [Connecting the Telemetry Port](#).
- The **OSD** button on the Ground Unit is set to enable the display of flight control (Telemetry) information.

When the Air Unit receives valid Telemetry messages from the drone flight controller, these messages are transmitted to the Ground Unit, which displays the additional Telemetry information on the OSD. This may require a few seconds to take effect.

For a list of supported flight controllers, [click here](#).

To display OSD information:

- While all LEDs on the Ground Unit are lit, press the OSD button on the Ground Unit. The following is an example of the OSD View:



OSD View – with Telemetry Information

Alert and System Messages

The tables below describe messages that may appear on the monitor connected to the Ground Unit HDMI port.

Alert Messages – Overlaid on Video During Link

These alert messages may be displayed on top of the live video:

Alert	Description
Out of Range	<p>A link still exists, but the video signal has been lost. This message is displayed regardless of the OSD button position.</p> <p>When the Air Unit is within range, the video signal is automatically reacquired.</p> <p>See video</p>
Approached Range Limit	<p>This alert is displayed for 30 seconds, from the moment the Air Unit has been detected as out of range until the Out of Range warning is displayed. The message is a warning that the video signal is about to be lost. We recommend flying the drone back within the range of the Ground Unit.</p> <p>This message is displayed only if the OSD button enables OSD display.</p> <p>See video</p>
Video Signal Not Detected	<p>A link has been established between the Air Unit and the Ground Unit, but no video signal has been detected. This message is displayed regardless of the OSD button position.</p>

System Messages – No Link

These system messages may be displayed when no live video is displayed:

Alert	Description
Searching for Air Unit	<p>This message is displayed until a link is established. This may occur when the Air Unit is out of range or unavailable, or when the Ground Unit has been removed from its list of paired devices.</p>
Pairing in Progress	<p>This message is displayed while the Air Unit is pairing with a Ground Unit.</p> <p>For a detailed description of the pairing process, click here.</p>

Multicasting to Multiple Ground Units

A single Air Unit can transmit [video downlink](#) to up to four Ground Units. This is called *multicasting*. The following procedure describes how to pair an additional Ground Unit with the same Air Unit.

Note: The Air and Ground Units provided in the same box are preconfigured to automatically search for and connect to each other. Therefore, there is no need to perform this procedure on the Air Unit / Ground Unit provided in the same box.

Note: Controlling the Air Unit's camera gimbal is not recommended when the Air Unit is registered to more than two Ground Units (even if only two of the registered Ground Units are powered ON).

Pairing Additional Ground Units with an Air Unit

To pair an additional Ground Unit with an Air Unit:

1. Set up the additional Ground Unit, as described in [Setting Up the CONNEX Ground Unit](#) or [Setting Up the CONNEX mini Ground Unit](#).

The Ground Unit must be placed between one and 10 meters from the Air Unit. Each Ground Unit must be placed at least a few meters away from other Ground Units in order to enable optimal reception.

The following message is then displayed on the monitor connected to the Ground Unit's **HDMI port**:

"Ground Unit not registered to Air Unit"

2. Press and hold the **Link** button on the Ground Unit (for approximately five seconds) until its **Network**  LED starts blinking. The following message is displayed on the monitor connected to the Ground Unit:

"Please activate registration on Air Unit"

3. Power on the Air Unit with which to pair this Ground Unit. This step assumes that the Air Unit has already been set up, as described in [Setting Up the CONNEX Air Unit](#) or [Setting Up the CONNEX mini Air Unit](#).

Press the Air Unit's **Link** button for approximately five seconds until the Network LED starts blinking. After the LED begins blinking, the following message is displayed on the monitor connected to the Ground Unit.

"Air Unit detected. Please press the Link button."

4. Press and release the **Link** button on the Ground Unit (do not press and hold). The following message is then displayed:

"Pairing in progress"

After a while, the monitor connected to the Ground Unit should display the video received from the Air Unit.

Note: If a black screen is displayed, check that the camera on the drone is operating.

To see a list of Ground Units with which an Air Unit is currently paired and connected:

You may refer to [Checking the Ground Units Registered to an Air Unit](#).

To clear Ground Units with which an Air Unit is paired:

You may refer to [Unregistering Ground Units](#).

8

CONNEX Management Application for Windows / MAC

This chapter presents:

- [Overview of the Management Application](#)
- [Installing the CONNEX Management Application](#)
- [Connecting the Air Unit or Ground Unit to a Computer](#)
- [Upgrading the Air Unit or Ground Unit Firmware](#)
- [Configuring the Link Between the Ground and Air Units](#)
- [Checking the Ground Units Registered to an Air Unit](#)
- [Unregistering Ground Units](#)
- [Configuring Fail Safe Parameters](#)

Management Application Overview

The Air Unit and the Ground Unit come preinstalled with the latest firmware version, and are preconfigured to communicate with each other. The CONNEX Management application is used when the following updates and verifications are required:

- [Reconfiguring the wireless video datalink](#)
- [Upgrading the firmware](#) of the Air Unit and the Ground Unit
- [Checking which Ground Units are registered to an Air Unit](#)
- [Unregistering Ground Units](#) from an Air Unit

To use the CONNEX Management application:

1. Install the CONNEX Management application, as described in [Installing the CONNEX Management Application](#).
2. Connect the Air Unit or Ground Unit to a computer, as described in [Connecting the Air Unit or Ground Unit to a Computer](#).

Note: Only a single CONNEX Air Unit or CONNEX Ground Unit can be connected to the CONNEX Management application at a time.

Installing the CONNEX Management Application

This application can run on a standard computer running either OS X 10.7 and up, or Windows 7 and up. For installation on Windows 8 or Windows 10 operating systems, please check [this article](#).

To install or upgrade the CONNEX Management application:

1. Download the latest version from the AMIMON website <http://connex.amimon.com/firmware-update> to a [computer connected to an Air Unit Ground Unit](#).
2. Run the installation file and follow the displayed instructions to install the CONNEX Management application.
3. Launch the application by double-clicking its desktop icon. The following window displays (Air Unit on left, Ground Unit on right):

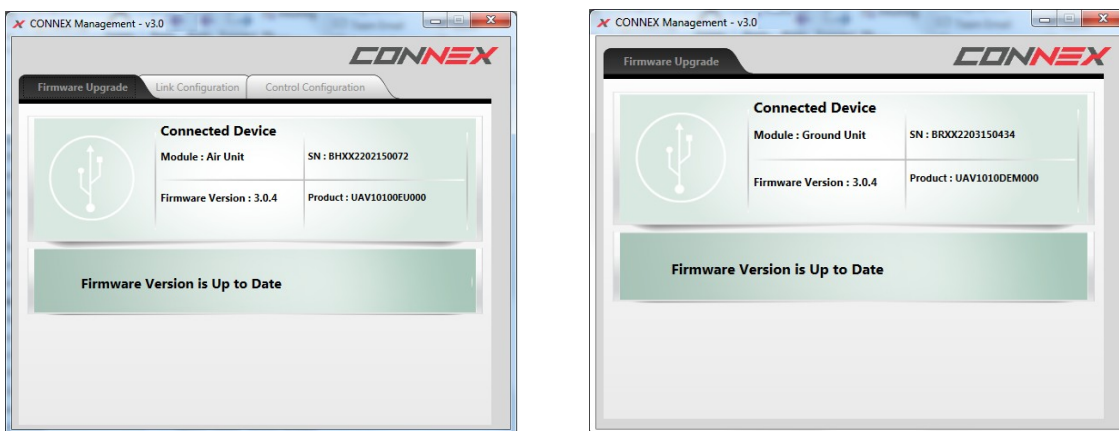

The current version of the CONNEX Management application is displayed in the upper left corner of the window.

Message Alert when running the Management Tool Installation Process in Win8/10

When installing the CONNEX Management Tool in Windows 8 and Windows 10, the following alert may appear:

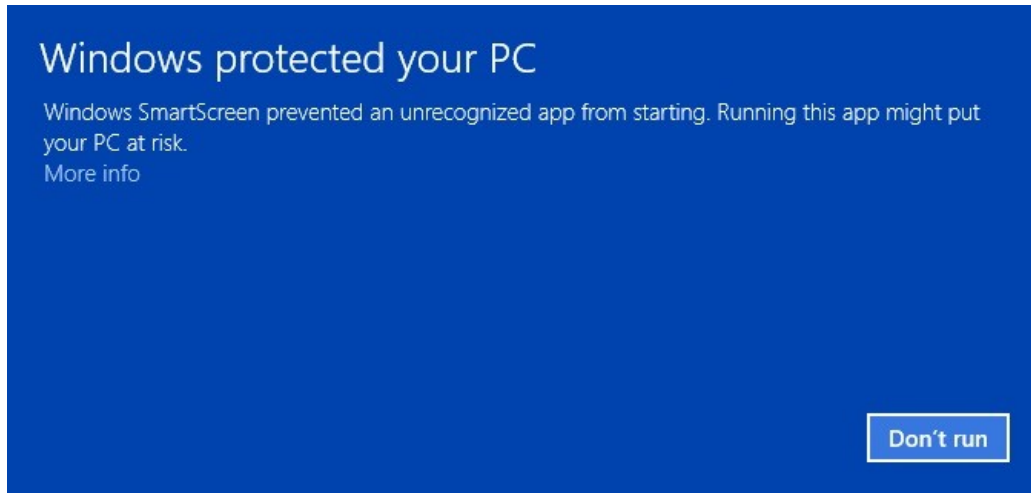

Continue with the installation by clicking the **More info** link.

Select the checkbox stating *'I understand the risk and want to run this app'* and then click **Run anyway** .

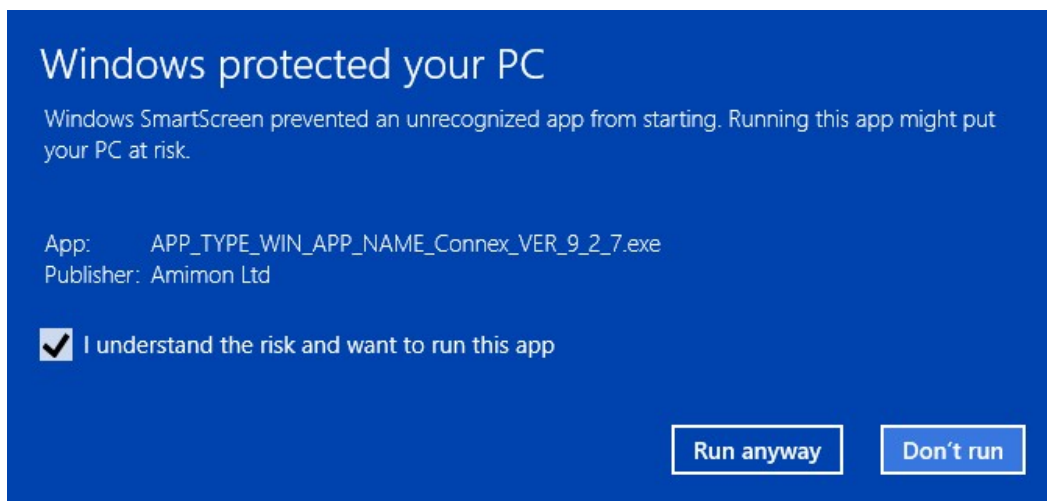

When installation is complete, the application operates normally, as described in [this article](#).

Connecting the Air Unit or Ground Unit to a Computer

The Air Unit or Ground Unit must be connected to a computer on which the CONNEX Management application is installed in order to configure or upgrade that unit.

To connect the Air Unit or Ground Unit to a computer:

- Connect the Micro USB cable (Box 6) to the Air Unit's or Ground Unit's USB port.



If you launch the CONNEX Management application before connecting an Air Unit or Ground Unit to the computer, the following message is displayed. Connect the unit, as described above.



Upgrading the Air Unit or Ground Unit Firmware

If the Connex Management tool displays an alert about a newer tool version, download the new version from: <http://connex.amimon.com/firmware-update>

Upgrading the Air Unit or Ground Unit firmware does not affect the settings of the [wireless video](#) downlink.

To supplement the instructions below, you can refer to the [CONNEX Firmware Upgrade](#) video.

To upgrade the Air Unit or Ground Unit firmware:

1. Make sure that the computer on which the CONNEX Management application is installed is connected to the Internet and is connected to the Air Unit/Ground Unit via a Micro USB cable.
2. Launch the CONNEX Management application by double-clicking its desktop icon. The following figures show the window displayed for the Air Unit (left) and for the Ground Unit (right). The **Firmware Upgrade** tab is selected by default. This is the only tab that appears for the Ground Unit.

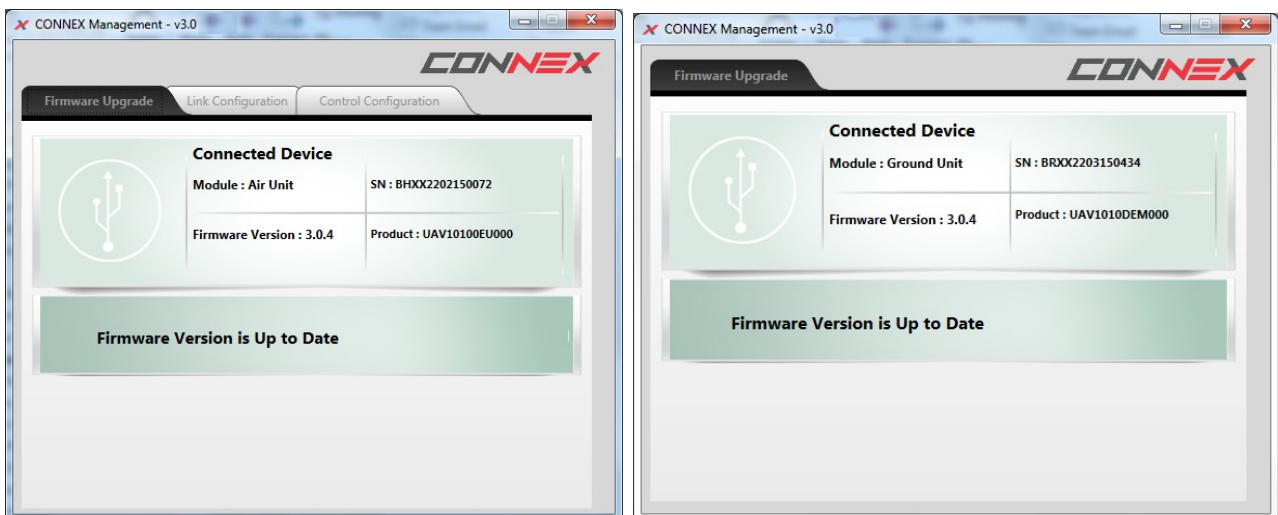

The window contains the following options:

- **Module:** Specifies whether the connected unit is an Air Unit (Tx) or a Ground Unit (Rx).
- **Firmware Version:** Specifies the version of the firmware currently installed on the unit.
- **SN:** Specifies the unique serial number of the unit.
- **Product:** Specifies the product ID of the unit.
- **Upgrade Button:** The application automatically checks with the AMIMON server whether the latest firmware version of the connected unit is installed. If the latest version is not installed, the **Upgrade** button is enabled and a **Newer Firmware Version Exists x.x.x** message appears.

3. Click the **Upgrade** button. The latest software version is automatically downloaded from the AMIMON server and installed on the connected unit. The lower portion of the window displays the progress of the upgrade and lists the processes as they are performed, as shown below:

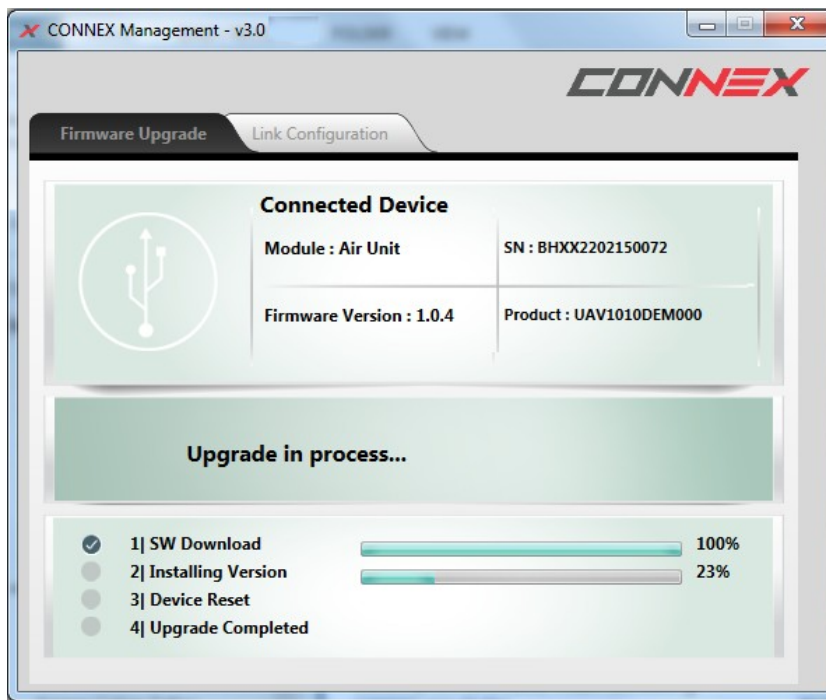

4. If you upgrade an Air Unit, you must also upgrade all Ground Units registered to it. We highly recommend that you begin the upgrade process only after the Air Unit and its Ground Units have been collected and are placed next to the computer.



An Air Unit and a Ground Unit with different software versions may not communicate with each other.

Configuring the Link Between the Ground and Air Units

This article describes how to configure the link between an Air Unit and its Ground Units. This procedure is performed on an Air Unit only.

The **Link Configuration** tab of the Management application is shown in the following figures (CONNEX on left, CONNEX mini on right). The link parameters are described in the table below the diagrams.



Key	Description
1	<p>Channel Mode: Determines the bandwidth of the wireless link. CONNEX users can select High Quality (40 MHz) or Stability Boost (20 MHz).</p> <p>Note: CONNEX mini units support High Quality mode only.</p>
2	<p>Frequency Mode: Determines whether automatic or fixed frequency is used. The options available for fixed frequency vary according to other options selected (regional settings and Channel Mode).</p> <p>Note: CONNEX mini units support Auto frequency mode only.</p>
3	<p>Regional Settings: Allows you to set the operating mode of the unit, according to regional regulations. The options are relevant for European, Chinese, Japanese, Korean and Australian regions.</p>

To configure the link:

1. Make sure that the computer on which the CONNEX Management application is installed is connected to the Air Unit via a Micro USB cable and is connected to the Internet.
2. Launch the CONNEX Management application by double-clicking its desktop icon.
3. Select the **Link Configuration** tab.
4. **For CONNEX units only:**
Select the bandwidth channel mode, as follows:
 - **Optimized Quality (40 MHz):** This is the default option which provides the best quality. This is the only option that can be used with 1080P60 video resolution.
 - **Range Boost (20 MHz):** Use this mode in harsh RF conditions or for long range operations. This mode enables higher stability, but supports only lower resolutions on the [video link](#).
5. **For CONNEX units only:**
Specify the frequency mode by selecting either **Auto** or one of the fixed frequencies listed. The fixed frequencies that are available vary according to other options selected.
6. The Regional Settings dropdown menu appears for CONNEX and CONNEX mini units used in Europe, Japan, China, Korea and Australia. (This dropdown menu is hidden when units are used in United States regions.)
Select options as follows:
 - In Europe, select either **Air To Ground** for 5.8 GHz, 25mW or **Indoor** for 5 GHz, 200mW, Ground use.
 - In Japan, select either **Indoor** or **Outdoor** .

Make sure that you select the frequency setting that complies with the local RF regulations in the region in which you are operating.
7. To apply the configured changes to the Air Unit, click the **Update** button. The update affects how the Air Unit communicates with all the Ground Units with which it is registered (the units that are listed in the Registered Receivers list in the lower right portion of the window).

Checking the Ground Units Registered to an Air Unit

This article explains how to check which Ground Units are paired with a specific Air Unit.

To verify which Ground Units are registered to an Air Unit:

1. Make sure that the computer on which the CONNEX Management application is installed is connected to the Air Unit via a Micro USB cable.
2. Launch the CONNEX Management application by double-clicking its desktop icon.
3. Click the **Link Configuration** tab.
4. The lower right portion of the window displays a list of the MAC IDs of the Ground Units registered with this Air Unit, for example:



Key	Description
1	Ground Units Registered to the Air Unit

The MAC ID of a specific Ground Unit can be seen using the CONNEX Management application.

Unregistering Ground Units

There are two options for unregistering Ground Unit(s) from an Air Unit, as described in the procedures below:

- Unregistering one device at a time
- Unregistering all devices simultaneously

To view a video about unregistering Ground units, [click here](#).

To unregister a single device:

1. Make sure that the computer on which the CONNEX Management application is installed is connected to the Internet and is connected to the **Air Unit** via a Micro USB cable.
2. Launch the CONNEX Management tool by double-clicking its desktop icon.
3. Click the **Link Configuration** tab.

The lower right portion of the window displays a list of Ground Units registered with the Air Unit, as shown here:



4. To unregister a Ground Unit, click on the X button in the relevant row (marked in RED in the image above).

To unregister all Ground Units:

1. Make sure that the computer on which the CONNEX Management application is installed is connected to the Internet and is connected to the **Air Unit** via a Micro USB cable.
2. Launch the CONNEX Management application by double-clicking its desktop icon.
3. Click the **Link Configuration** tab.

The lower right portion of the window displays a list of Ground Units registered with the Air Unit, as shown here:



4. Click the **Unregister all receivers** button (marked in RED in the image above).
For information about registering Ground Units, refer to [Multicasting to Multiple Ground Units](#).

Configuring Fail Safe Parameters

The **Control Configuration** tab of the Management application allows you to set the parameters that are applied when the remote control wireless uplink is broken. The parameters are described in the table below the diagram.



Key	Description
1	Timeout: Determines the length of time (in seconds) between losing communication and applying Fail Safe values onto the output of the Air Unit.
2	S.BUS Rate: Specifies the data rate of the S.BUS link between the Ground Unit and the Air Unit that controls the Air Unit’s camera gimbal. By default, the data rate of the S.BUS remote control is 6.3mSec (FASSTest 12CH).
3	Channel Settings: Determines the position of the gimbal following a loss of communication. Each channel can be set to: <ul style="list-style-type: none"> • Hold: The most recent value (prior to the communication loss) is maintained. • Set: A new value is used. Values are configured in % (from -100 to +100).

IMPORTANT: It is recommended to utilize the CONNEX link for Gimbal control ONLY and NOT for full drone control.

To set Fail Safe parameters:

1. Make sure that the computer on which the CONNEX Management application is installed is connected to the Air Unit via a Micro USB cable and is connected to the Internet.
2. Launch the CONNEX Management application by double-clicking its desktop icon.
3. Select the **Control Configuration** tab.
4. From the **Timeout** dropdown menu, select the relevant option (1, 2, or 3 seconds).
5. If required, manually set the outgoing S.BUS bit-rate by selecting one of the following S.BUS Rate modes:
 - **Auto: 15m sec:** FASSTest 18CH or T-FHSS Mode. The S.BUS rate is received and sampled from the remote control trainer port. The Air Unit then automatically outputs the same S.BUS rate.
 - **6.3m sec:** FASSTest 12CH Mode.
6. For each channel in the **Channel Settings** frame, select either the **Hold** or **Set** radio button.
If you select the **Set** radio button, enter the required value in the field in the **Data** column. Values are configured in % and may range from -100 to +100.
7. To apply the configured changes, click the **Update** button. The update affects how the Air Unit communicates with all the Ground Units with which it is registered.

9

CONNEX Management Application for Android Devices

This chapter presents:

- [Management Application Overview](#)
- [Installing the CONNEX Management Application](#)
- [Connecting the Air or Ground Unit to Your Mobile Device](#)
- [Working with the CONNEX Android Application](#)
- [Configuring the Link Between the Air and Ground Units](#)
- [Checking the Ground Units Registered to an Air Unit](#)
- [Unregistering Ground Units](#)
- [Configuring Fail Safe Parameters](#)

Management Application Overview

The Air Unit and the Ground Unit come preinstalled with the latest firmware version, and are preconfigured to communicate with each other. The CONNEX Management application is used when the following updates and verifications are required:

- [Reconfiguring the wireless video datalink](#)
- [Checking which Ground Units are registered to an Air Unit](#)
- [Unregistering Ground Units](#) from an Air Unit

To use the CONNEX Management application:

1. Install the CONNEX Management application, as described in [Installing the CONNEX Management Application](#).
2. Connect the Air Unit or Ground Unit to a mobile device, as described in [Connecting the Air Unit or Ground Unit to a Mobile Device](#).

Note: Only a single CONNEX Air Unit or CONNEX Ground Unit can be connected to the CONNEX Management application at a time.

Installing the CONNEX Management Application

The CONNEX Management application for mobile devices is currently supported on Android devices with operating systems 4.4 and higher. In addition, the mobile device needs to support USB OTG capability.

To install the CONNEX Management application:

1. Download the latest version from Google Play to a [device connected to an Air Unit or Ground Unit](#).
2. Run the installation file and follow the displayed instructions to install the application.
3. Launch the application.

The **My Device** screen is displayed.

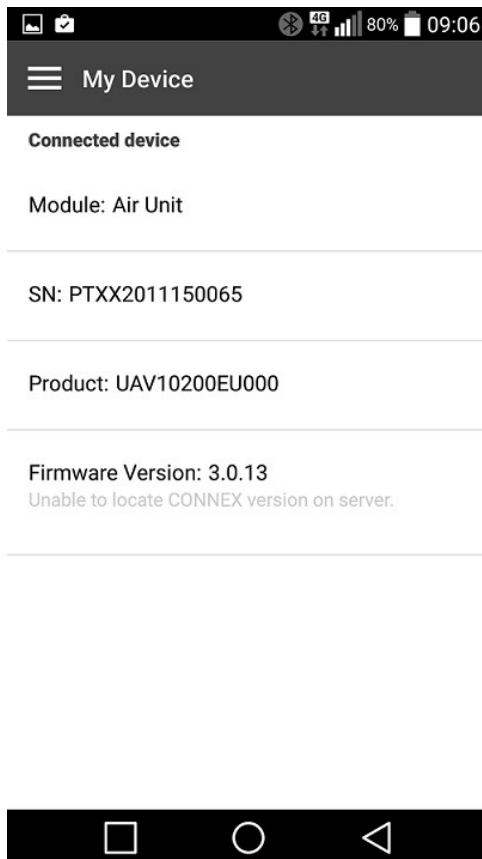

For more information about the **My Device** screen and the different menu options, refer to [Working with the CONNEX Android application](#).

Connecting the Air or Ground Unit to Your Mobile Device

The Air Unit or Ground Unit must be connected to a mobile device on which the CONNEX Management application is installed in order to configure that unit.

To connect the Air Unit or Ground Unit to a mobile device:

- Connect the USB to Micro USB connector to the Air Unit's or Ground Unit's USB port.



If you launch the CONNEX Management application before connecting an Air Unit or Ground Unit to your mobile device, the following message is displayed. Connect the unit, as described above.

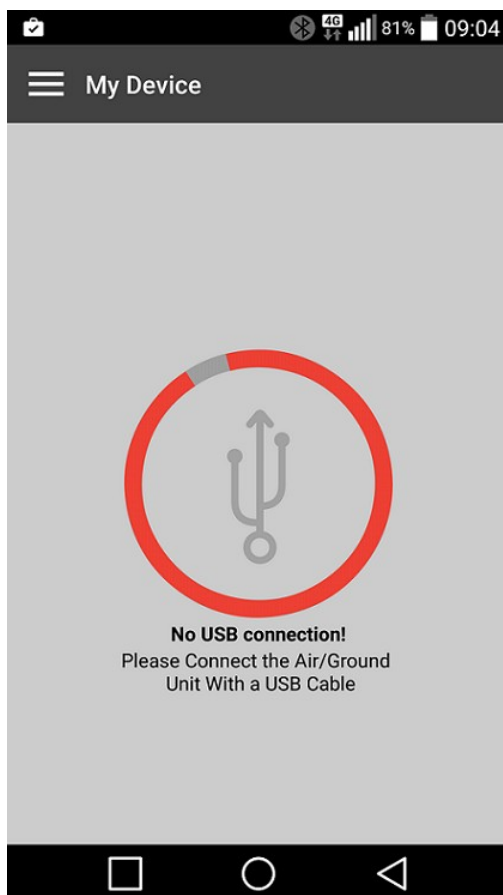

Working with the CONNEX Mobile Application

The following sections provide a general overview of the application's main screens and features:

- My Device Screen
- [Main Menu Options](#)
- [Basic Application Components](#)

My Device Screen

When you launch the CONNEX Management application, the **My Device** screen opens:

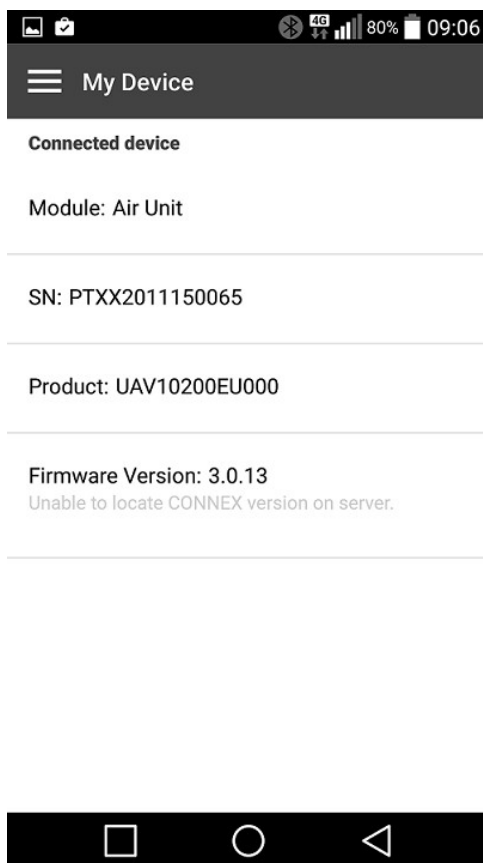

This screen displays the following information:

- **Module:** Specifies whether the connected unit is an Air Unit (Tx) or a Ground Unit (Rx).
- **SN:** The unique serial number of the unit.
- **Product:** The product ID of the unit.
- **Firmware Version:** The version of the firmware currently installed on the unit. The application automatically checks with the AMIMON server whether the latest firmware version of the connected unit is installed.

If the latest version is installed, a *Firmware Version is Up to Date* message is displayed.

To exit the **My Device** screen and view the menu options, press the Navigation icon, at the upper left corner of the page: 

Main Menu Options

The main menu screens are shown below (Air Unit on left and Ground Unit on right). Note that when a Ground

Unit is connected to your mobile device, only the **My Device** and **Support** options are available.

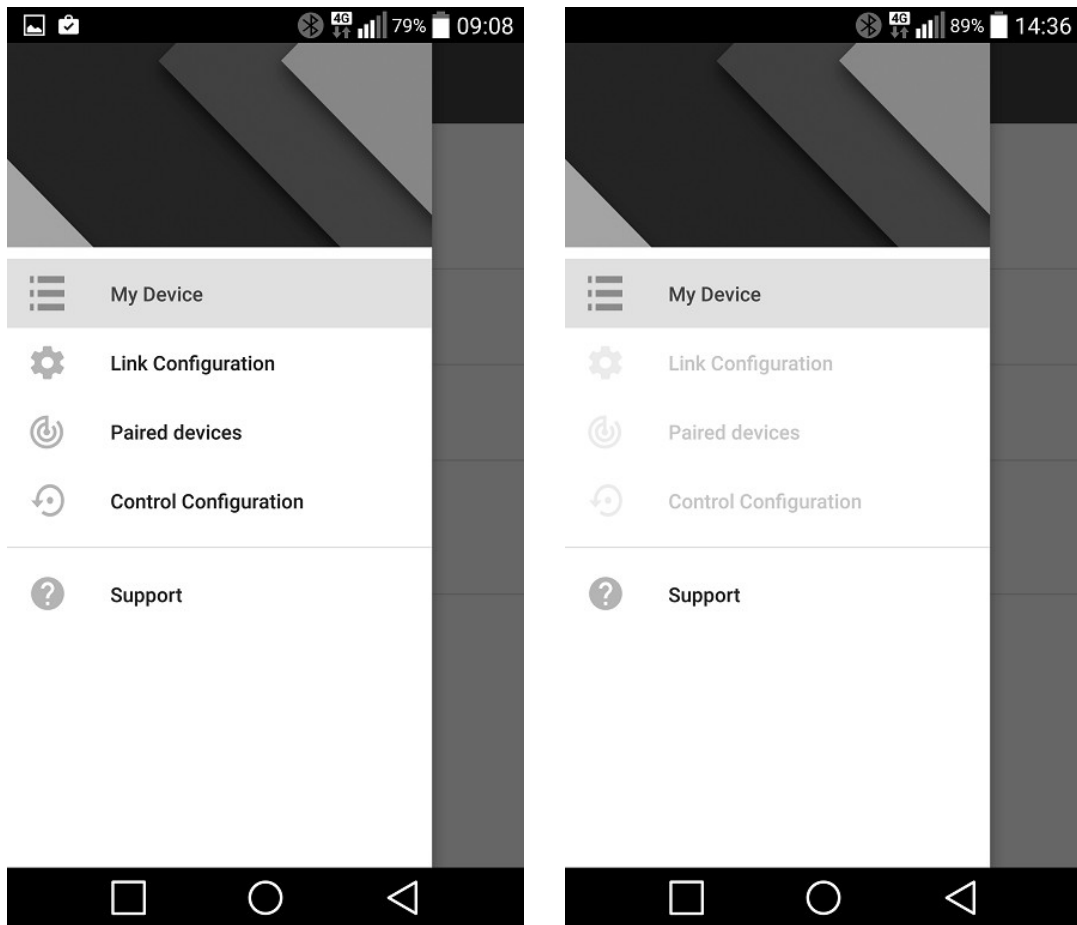

The menu options are summarized in the following table.

Option	Description	Supported for Ground Unit
My Device	Displays details about the Air or Ground Unit that is connected.	Yes
Link Configuration	Allows you to configure the link between an Air Unit and its Ground Units.	No
Paired Devices	Lists the Ground Units that are registered with the connected Air Unit, and enables you to unregister one or more of them.	No
Control Configuration	Allows you to view and modify Fail Safe parameters .	No
Support	Redirects you to the CONNEX online Help Center.	Yes

Basic Application Components

This section explains general features that enable you to work with the mobile application quickly and effectively. The components are described in the table below the diagram.

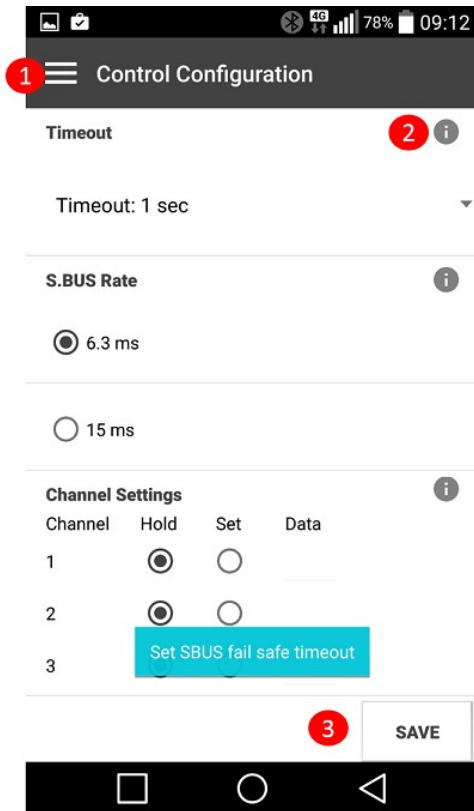

Number	Feature Name	Description
1	Navigation button	Use this button to navigate back to the main menu.
2	Information icon	Press these icons to open popups that provide short explanations about the relevant feature. An example is shown in the figure above.
3	Save button	Press this button to save any changes that you have made on a page. If you navigate back to the main menu without pressing Save , your changes will not be saved.

Configuring the Link Between the Ground and Air Units

This article describes how to configure the link between an Air Unit and its Ground Units. This procedure is performed on an Air Unit only.

The **Link Configuration** screen of the Management application is shown in the following figures (CONNEX on left, CONNEX mini on right). The link parameters are described in the table below the diagrams.

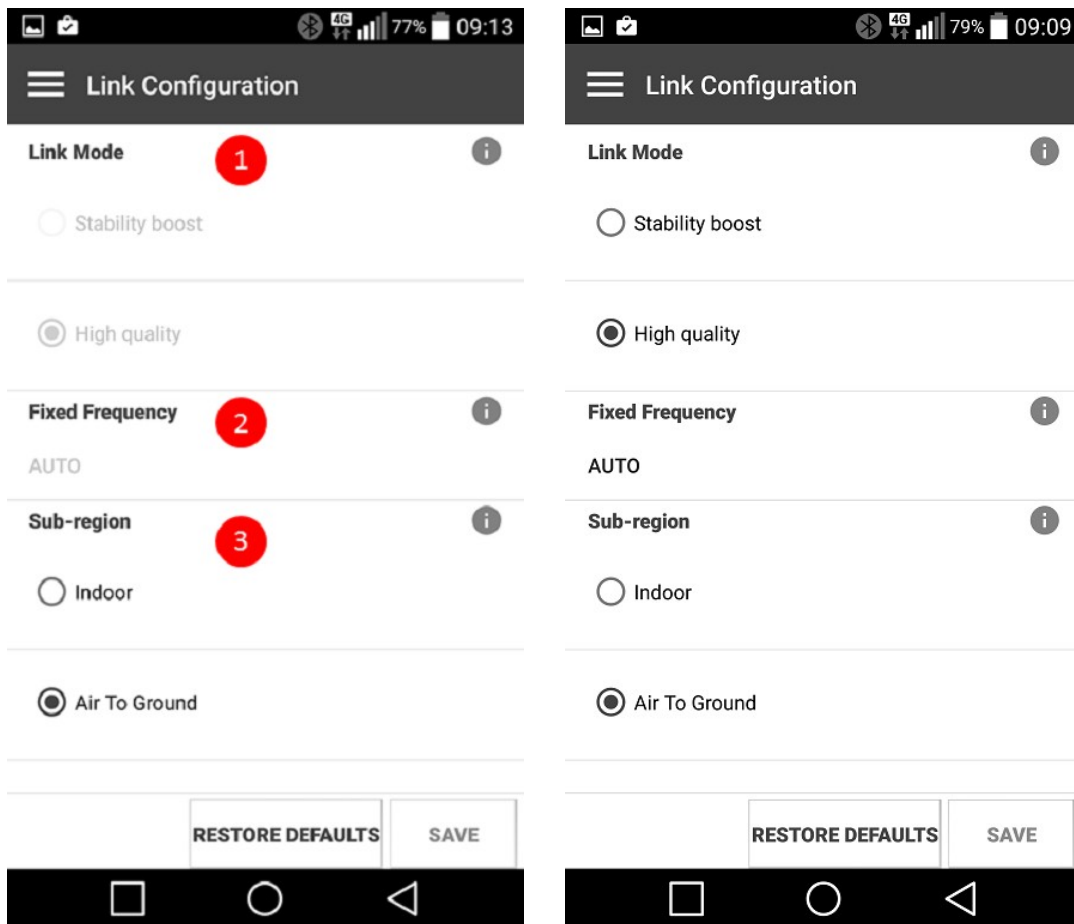

Key	Description
1	<p>Link Mode: Determines the bandwidth of the wireless link. CONNEX users can select High Quality (40 MHz) or Stability Boost (20 MHz).</p> <p>Note: CONNEX mini units support High Quality mode only.</p>
2	<p>Frequency Mode: Determines whether automatic or fixed frequency is used. The options available for fixed frequency vary according to other options selected (regional settings and Channel Mode).</p> <p>Note: CONNEX mini units support Auto frequency mode only.</p>

3

Sub-region Settings: Allows you to set the operating mode of the unit, according to regional regulations. The options are relevant for European, Chinese, Japanese, Korean and Australian regions.

To configure the link:

1. Make sure that the mobile device on which the CONNEX Management application is installed is connected to the Air Unit via a USB to Micro USB cable and is connected to the Internet.
2. Launch the CONNEX Management application, and navigate to the **Link Configuration** screen.
3. **For CONNEX units only:**
Select the bandwidth channel mode, as follows:
 - **High Quality (40 MHz):** This is the default option which provides the best quality. This is the only option that can be used with 1080P60 video resolution.
 - **Stability Boost (20 MHz):** Use this mode in harsh RF conditions or for long range operations. This mode enables higher stability, but supports only lower resolutions on the [video link](#).
4. **For CONNEX units only:**
Specify the frequency mode by selecting either **Auto** or one of the fixed frequencies listed. The fixed frequencies that are available vary according to other options selected.
5. The **Sub-region** options appear for CONNEX and CONNEX mini units used in Europe, Japan, China, Korea and Australia. (This dropdown menu is hidden when units are used in United States regions.) Select options as follows:
 - In Europe, select either **Air To Ground** for 5.8 GHz, 25mW or **Indoor** for 5 GHz, 200mW, Ground use.
 - In Japan, select either **Indoor** or **Outdoor** .

Make sure that you select the frequency setting that complies with the local RF regulations in the region in which you are operating.
6. To apply the configured changes to the Air Unit, press **Save**.
To return to the out-of-the-box factory settings, press **Restore Defaults**.

Note: A configuration update affects how the Air Unit communicates with all the [Ground Units with which it is registered](#).

Checking the Ground Units Registered to an Air Unit

This article explains how to check which Ground Units are paired with a specific Air Unit.

To verify which Ground Units are registered to an Air Unit:

1. Make sure that the mobile device on which the CONNEX Management application is installed is connected to the Air Unit via a USB to Micro USB cable.
2. Launch the CONNEX Management application, and navigate to the **Paired Devices** screen.

This screen displays a list of the MAC IDs of the Ground Units registered with this Air Unit. For example:

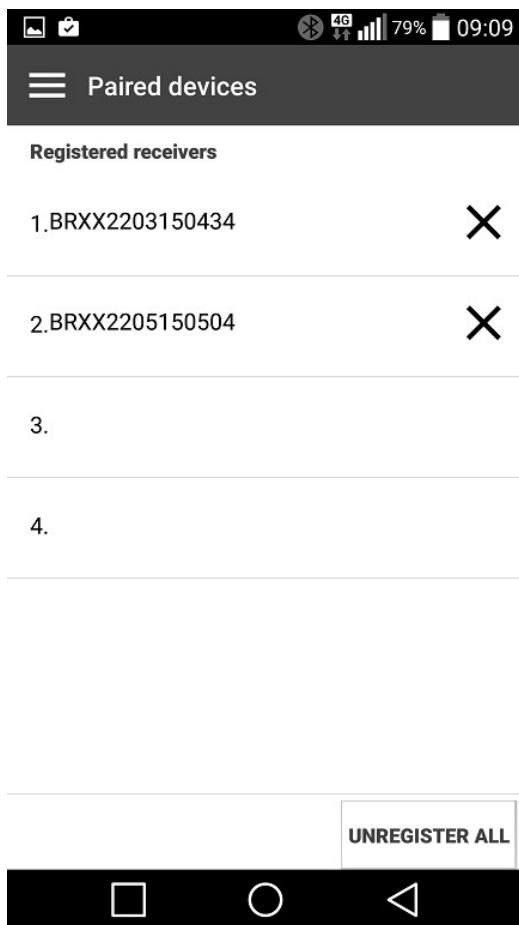

For information about unregistering Ground Units, [click here](#).

Unregistering Ground Units

There are two options for unregistering Ground Unit(s) from an Air Unit, as described in the procedures below:

- Unregistering one device at a time
- Unregistering all devices simultaneously

To unregister a single device:

1. Make sure that the mobile device on which the CONNEX Management application is installed is connected to the Internet and is connected to the **Air Unit** via a USB to Micro USB cable.
2. Launch the CONNEX Management application, and navigate to the **Paired Devices** screen.

This screen displays a list of Ground Units registered with the Air Unit. For example:

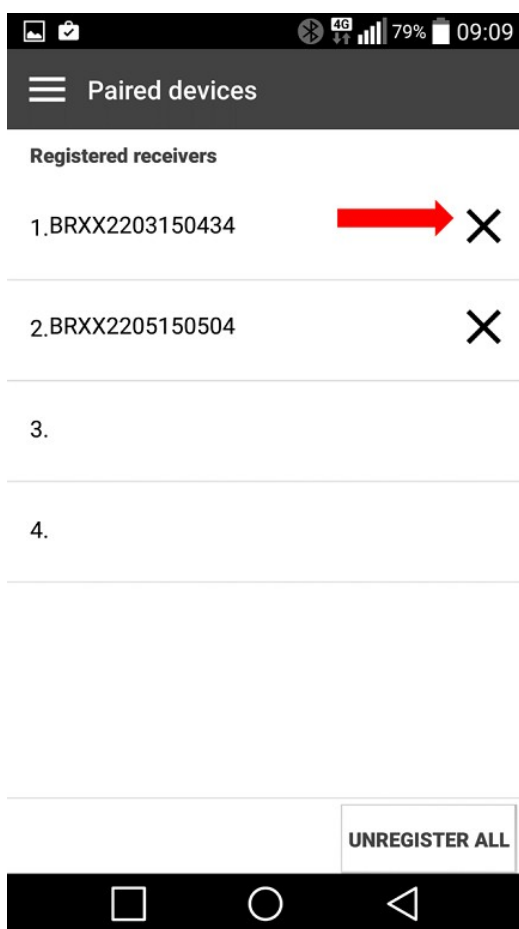

3. To unregister a Ground Unit, press the X button in the relevant row (marked in RED in the image above).

To unregister all Ground Units:

1. Make sure that the mobile device on which the CONNEX Management application is installed is connected to the Internet and is connected to the **Air Unit** via a USB to Micro USB cable.
2. Launch the CONNEX Management application, and navigate to the **Paired Devices** screen.

This screen displays a list of Ground Units registered with the Air Unit, as shown here:

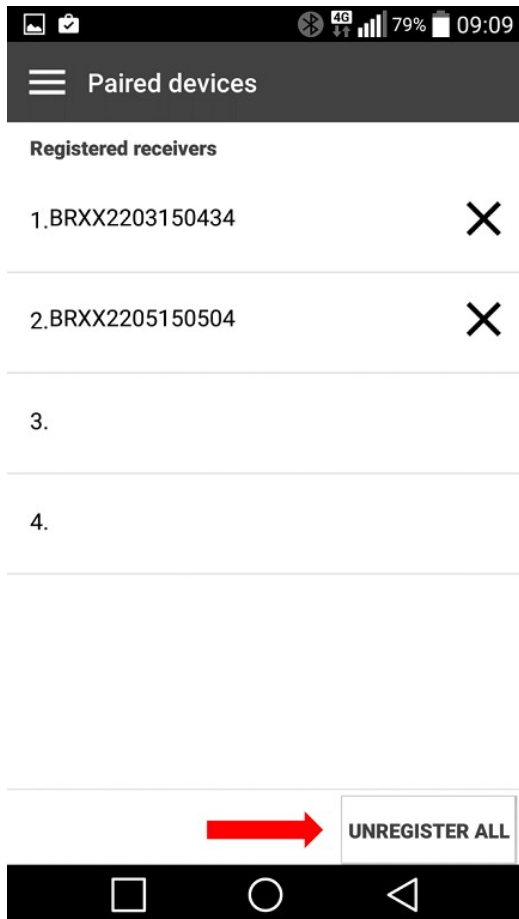

3. Press the **Unregister All** button (marked in RED in the image above).

For information about registering Ground Units, refer to [Multicasting to Multiple Ground Units](#).

Configuring Fail Safe Parameters

The **Control Configuration** screen of the Management application allows you to set the parameters that are applied when the remote control wireless uplink is broken. The parameters are described in the table below the diagram.

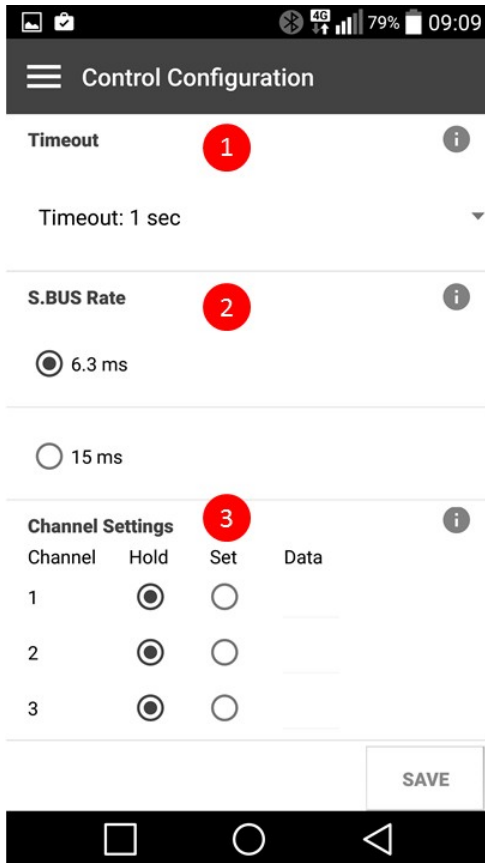

Key	Description
1	Timeout: Determines the length of time (in seconds) between losing communication and applying Fail Safe values onto the output of the Air Unit.
2	S.BUS Rate: Specifies the data rate of the S.BUS link between the Ground Unit and the Air Unit that controls the Air Unit's camera gimbal. By default, the data rate of the S.BUS remote control is 6.3mSec (FASSTest 12CH).
3	Channel Settings: Determines the position of the gimbal following a loss of communication. Each channel can be set to: <ul style="list-style-type: none"> • Hold: The most recent value (prior to the communication loss) is maintained. • Set: A new value is used. Values are configured in % (from -100 to +100).

IMPORTANT: It is recommended to utilize the CONNEX link for Gimbal control ONLY and NOT for full drone control.

To set Fail Safe parameters:

1. Make sure that the mobile device on which the CONNEX Management application is installed is connected to the Air Unit via a USB to Micro USB cable and is connected to the Internet.
2. Launch the CONNEX Management application, and navigate to the **Control Configuration** screen.
3. From the **Timeout** dropdown menu, select the relevant option (1, 2, or 3 seconds).
4. If required, manually set the outgoing S.BUS bit-rate by selecting one of the following S.BUS Rate modes:
 - o **Auto: 15m sec:** FASSTest 18CH or T-FHSS Mode. The S.BUS rate is received and sampled from the remote control trainer port. The Air Unit then automatically outputs the same S.BUS rate.
 - o **6.3m sec:** FASSTest 12CH Mode.
5. For each channel in the **Channel Settings** frame, select either the **Hold** or **Set** radio button.
 If you select the **Set** radio button, enter the required value in the field in the **Data** column. Values are configured in % and may range from -100 to +100.

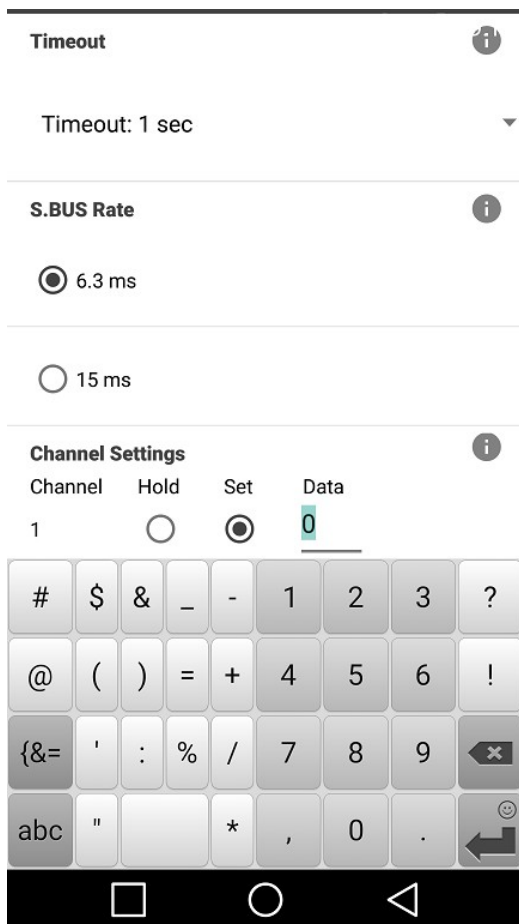

6. To apply the configured changes, press **Save**. The update affects how the Air Unit communicates with all the [Ground Units with which it is registered](#).